



Mast Pak

Surgical Corporation

Manufacturer & Exporters of surgical instruments



ENT, Ear, Nose, Throat

Instruments

Website: www.mastpaksurgicalcorp.com

Email: info@mastpaksurgicalcorp.com

Phone: +92-324-8609456

Address: Pacca Garha, Kashmir Road
Sialkot 51310, Pakistan

About us:

A team of professional experts joined hands to form MAST PAK SURGICAL CORPORATION with the sole aim to export high Quality surgical Instruments, Specialist in Needle Holder Forceps with Tungsten carbide.

Our products were advertised throughout the world by the help of catalogues, Internet, Exhibitions & personal visits to different countries of the world. These efforts bore fruit and we managed to establish our credibility and began exporting our products.

MAST PAK SURGICAL CORPORATION achieved tremendous success by virtue of constant dedicated efforts, devotion to duty and maintenance of quality control. This quality management system was properly implemented and is being successfully executed at all production stages, which indeed a result of constant professional and vigorous team effort undertaken by MAST PAK SURGICAL CORPORATION most responsible, professional and dedicated staff members.

Its always been our endeavor to maintain a high standard of production, quality control and customer satisfaction. We finally offer our sincere regard and gratitude to all our valued clients for patronizing MAST PAK SURGICAL CORPORATION and helping us to achieve our goals.

Our Mission

Establish a global presesnce as a leading designer and manufacturer of high quality handled surgical instruments in the dental and medical surgical fields.

Our goal will be achieved through the offering of excellent products and services: and by our commitment of exceed customer expectations.

Achievements

High achievement always takes place in the framework of high expectations.

General Instruments

Probes, cotton applicators, spatulas
Sondes, porte-cotons, spatules
Sondas, porta-algodones, espátulas



Probes, cotton applicators, spatulas
Sondes, porte-cotons, spatules
Sondas, porta-algodones, espátulas

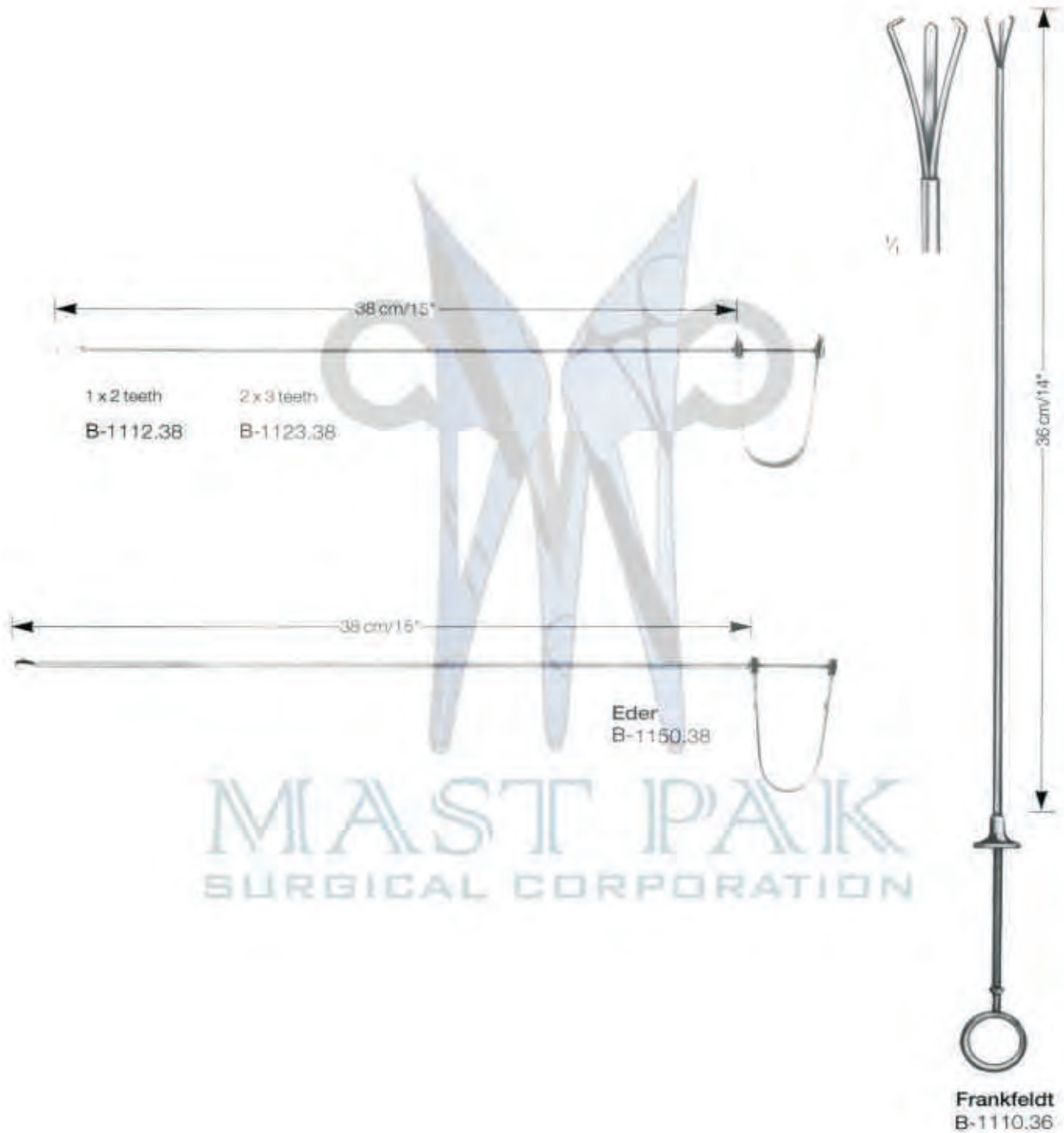

**Trocars
Trocart
Trócares**



Douglas
Ø 3 mm
B-3115.30

Lichtwitz
15 cm/6"
Ø 2 mm
B-3122.20

Pierce
17 cm/6 7/8"
B-3131.30 Ø 3 mm
B-3131.40 Ø 4 mm
B-3131.50 Ø 5 mm

Coakley
14 cm/5 1/2"
Ø 3 mm
B-3135.30



Krause
16 cm/6 1/4"
Ø 5,5 cm
B-3140.55



Lichtwitz
19 cm/7 1/2"
Ø 1,8 mm
B-3154.18



Lichtwitz-Bier
with Luer connection

1,0 mm Ø x 80 mm B-3170.10
1,2 mm Ø x 80 mm B-3170.12
1,5 mm Ø x 80 mm B-3170.15
1,8 mm Ø x 100 mm B-3170.18

MASTPAK
SURGICAL CORPORATION

Antrum Puncture Needles:

Ear and nasal dressing forceps
Pinces auriculaires et nasaux
Pinzas auriculares y nasales

Columnella Forceps



Masing
 8,5 cm/3 1/8"
 C-5402.85



Cottle
 11 cm/4 3/8"
 C-5404.11



Troeltsch (Wilde)
 11 cm/4 3/8"
 C-5607.11



Troeltsch (Wilde)
 13 cm/5"
 C-5607.13



Troeltsch
 15 cm/6"
 C-5607.15



Troeltsch
 13 cm/5"
 C-5611.13



Lucae
 14 cm/5 1/2"
 C-5655.14



Jansen
 15 cm/6 1/8"
 C-5655.16



Jansen
 19 cm/7 1/2"
 C-5655.19



Lucae
 14 cm/5 1/2"
 C-5663.14



Jansen
 16 cm/6 1/4"
 C-5663.16

MAST PAK
 SURGICAL CORPORATION

1 x 2 Zinne
 1 x 2 teeth
 1 x 2 dentes
 1 x 2 dents

1 x 2 teeth

Fine hemostatic forceps
Pinces hémostatiques fins
Pinzas hemostáticas finas

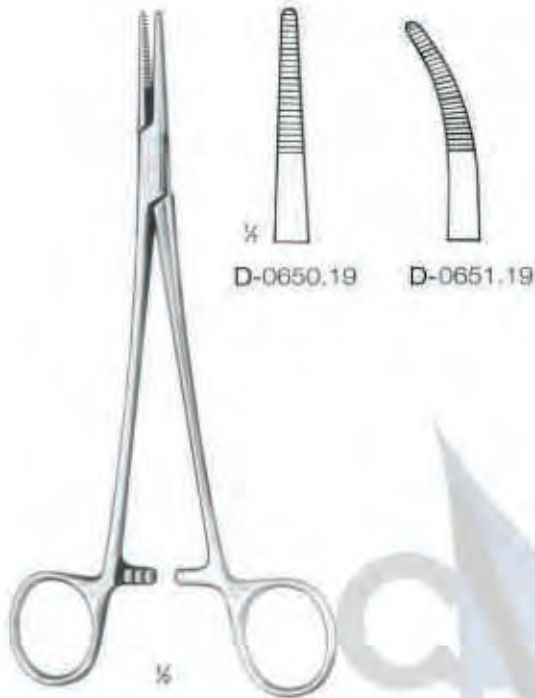

Adson
 19 cm/7 1/2"



Dandy
 14 cm/5 1/2"
 D-0671.14



Providence-Hospital
 14 cm/5 1/2"



Leriche
 15 cm/6"

MAST PAK
 SURGICAL CORPORATION

Fine hemostatic forceps
Pinces hémostatiques fins
Pinzas hemostáticas finas



Birkett
 19 cm/7 1/2"

Heiss
 20 cm/8"



Olivecrona (Crafoord)

Crafoord (Coller)

Wire Cutting scissors
Ciseaux pour couper les fils d'acier
Cizallas para cortar alambre

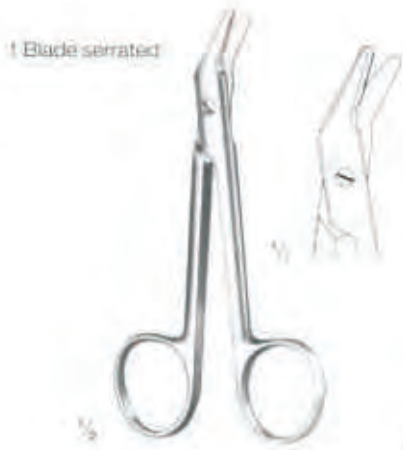

Universal
 12 cm/4 3/8"
 F-5101.12



Harvey
 12,5 cm/5"
 F-5100.12

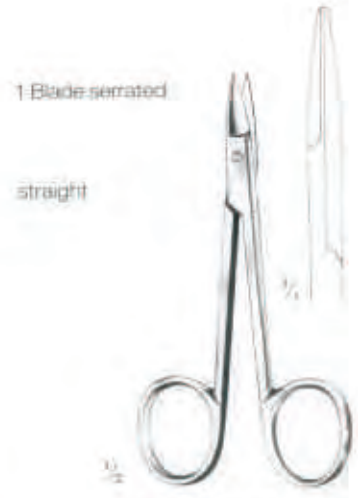

Schuknecht
 10 cm/4"
 F-5110.10



Smith
 17 cm/6 3/4"
 F-5116.17



Beebee
 12 cm/4 3/8"
 F-5120.12

smooth



Beebee
 12 cm/4 3/8"
 F-5121.12

smooth

MAST PAK
 SURGICAL CORPORATION

Fine scissors, wire cutting scissors
Ciseaux fins, Ciseaux coupe fils
Tijeras finas, Cizellas para cortar alambre

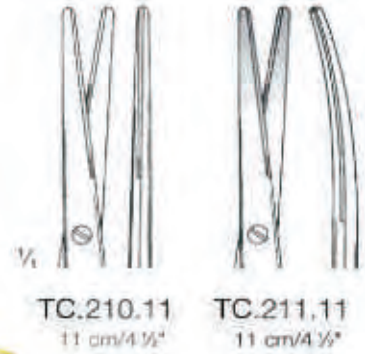
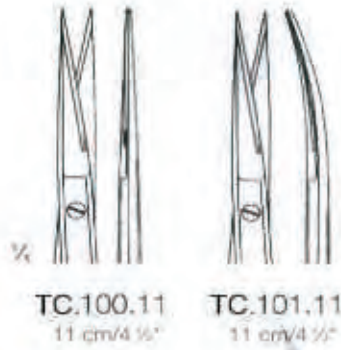

for soft wire up to mm Ø
 for hard wire up to Ø

1.0 mm
 0.6 mm

1.0 mm
 0.6 mm



MAST PAK
 SURGICAL CORPORATION

Fine dissecting scissors
Ciseaux fins à dissection
Tijeras finas para preparaciones



Kilner

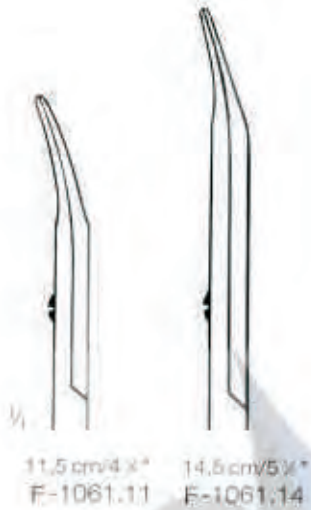

11,5 cm/4 1/2" F-1061.11
 14,5 cm/5 3/4" F-1061.14

curved

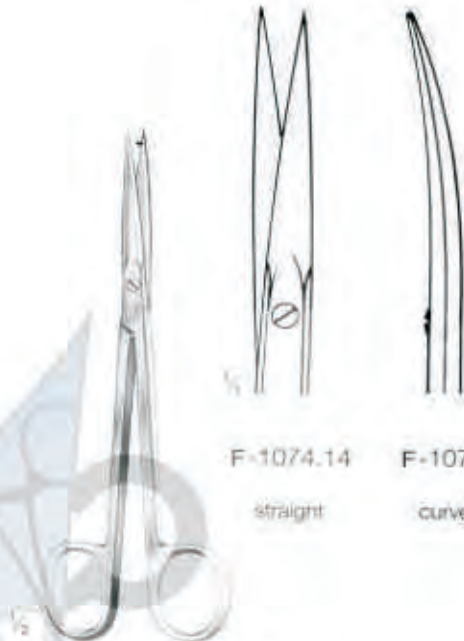

Brophy (Sullivan)
 14,5 cm/5 1/2"

F-1074.14 F-1075.14

straight

curved



Tönnis (House)
 18 cm/7"



F-1080.18 F-1081.18

straight

curved



Tönnis-Adson
 17,5 cm/7"
 F-1085.18



curved

MAST PAK
 SURGICAL CORPORATION

Fine dissecting scissors
Ciseaux fins à dissection
Tijeras finas para preparaciones

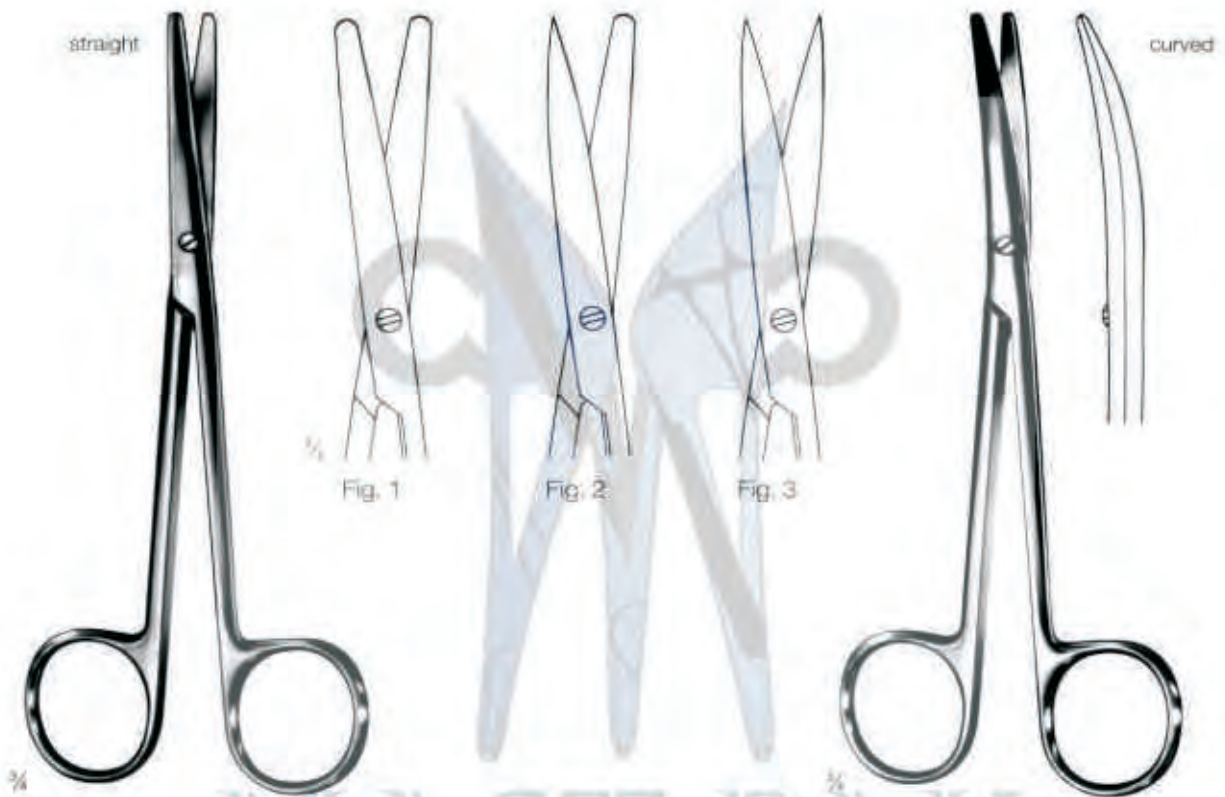

Metzenbaum (Lahey)
 14,5 cm/5 1/2"

Metzenbaum (Lahey)
 14,5 cm/5 1/2"

F-1210,14	Fig. 1	F-1211,14
F-1220,14	Fig. 2	F-1221,14
F-1230,14	Fig. 3	F-1231,14

Fine dissecting scissors
Ciseaux fins à dissection
Tijeras finas para preparaciones

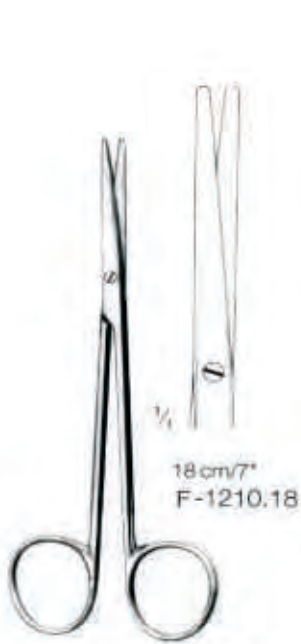

18 cm/7"
F-1210.18

Metzenbaum-Fino
F-1210.##



20 cm/8"
F-1210.20



23 cm/9"
F-1210.23



25 cm/10"
F-1210.25



28 cm/11"
F-1210.28

S-curved

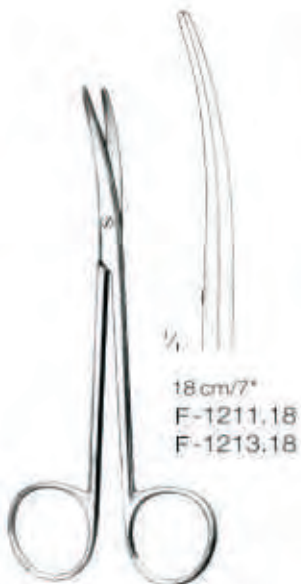

18 cm/7"
F-1211.18
F-1213.18

Metzenbaum-Fino
F-1211.##



20 cm/8"
F-1211.20
F-1213.20



23 cm/9"
F-1211.23
F-1213.23



25 cm/10"
F-1211.25
F-1213.25



28 cm/11"
F-1211.28
F-1213.28



Metzenbaum-Fino
F-1213.##

MASTPAK
SURGICAL CORPORATION

Fine dissecting scissors
Ciseaux fins à dissection
Tijeras finas para preparaciones



Metzenbaum-Fino
F-1230.##



18 cm/7"
F-1230.18

20 cm/8"
F-1230.20



23 cm/9"
F-1230.23



Metzenbaum-Fino
F-1231.##



18 cm/7"
F-1231.18



20 cm/8"
F-1231.20



23 cm/9"
F-1231.23

MAST PAK
SURGICAL CORPORATION

Thoracic scissors
Ciseaux pulmonaires
Tijeras torácicas



Finochietto
27 cm/10 mm*
F-4021.27

Crafoord
30 cm/11 mm*
F-4033.30

Willauer		
cm	inch.	
25	10	F-4045.25
28	11	F-4045.28

Gynecological scissors
Ciseaux gynécologiques
Tijeras para ginecología



Abdominal Scissors,



Gynecological scissors
Ciseaux gynécologiques
Tijeras para ginecología

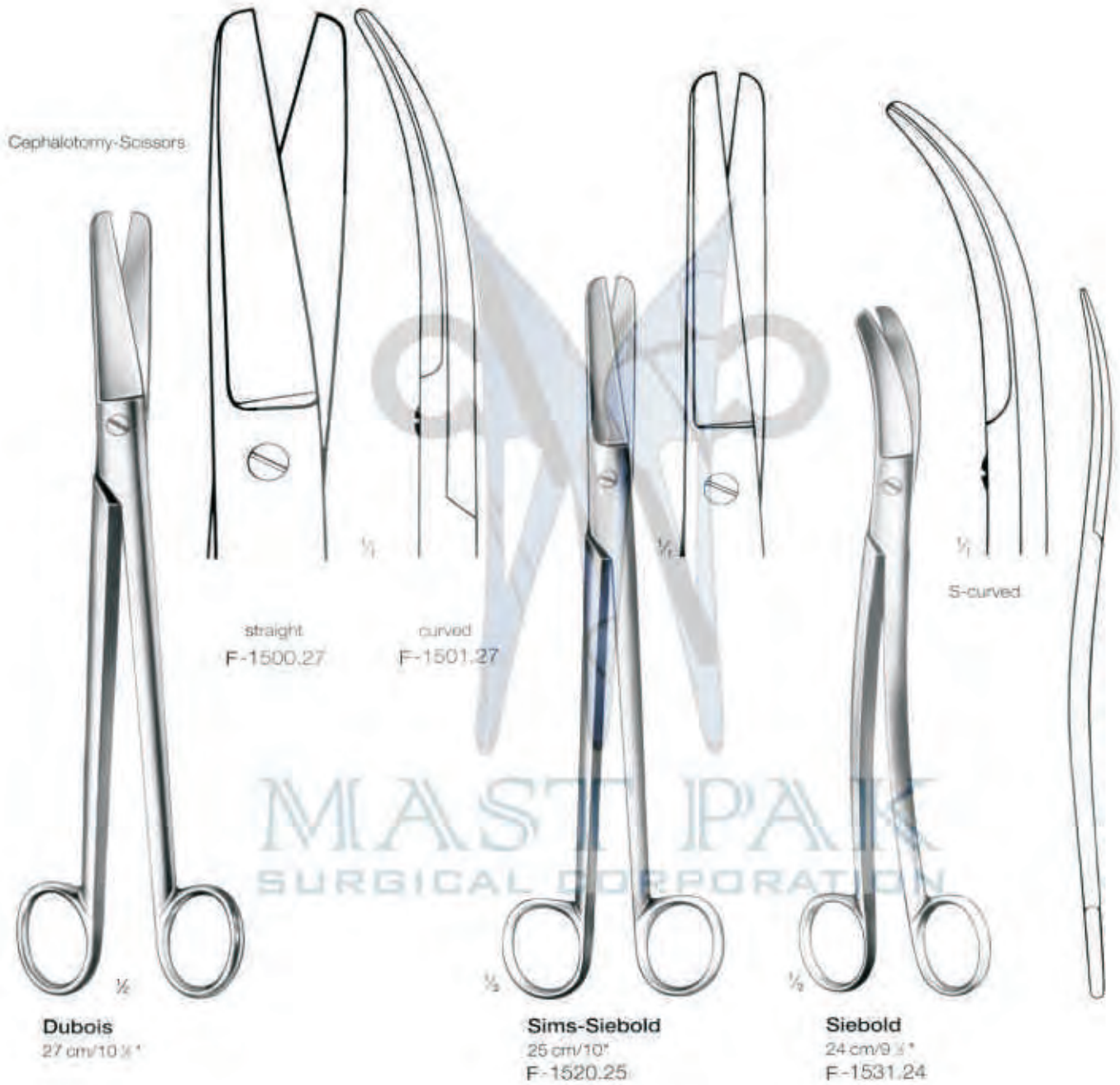

Gynecological scissors
Ciseaux gynécologiques
Tijeras para ginecología



Braun-Stadler
14 cm/5 1/2"
F-1605.14



Braun-Stadler
22 cm/8 1/2"
F-1605.22



Marbach
15,5 cm/6"
F-1613.15

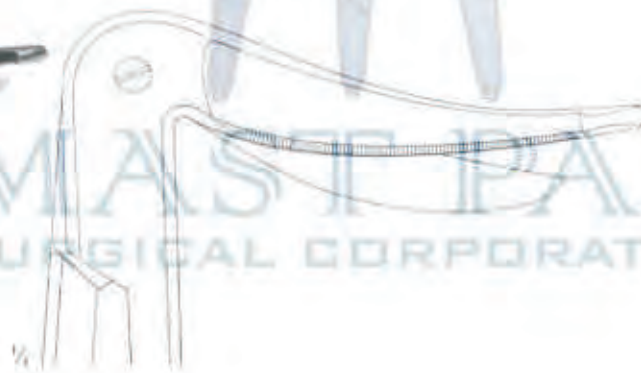

Waldmann
18 cm/7"
F-1617.18

MASTPAK
SURGICAL CORPORATION

Gynecological scissors
Ciseaux gynécologiques
Tijeras para ginecología



Gynecological scissors
Ciseaux gynécologiques
Tijeras para ginecología

Umbilical Cord Scissors



Mod. USA
10,5 cm 4"
F-1636.10



Busch
16 cm 6 3/8"
F-1641.16

Schumacher
16 cm 6 3/8"
F-1645.16

Cartilage scissors
Ciseaux pour cartilage
Tijeras para cartilago

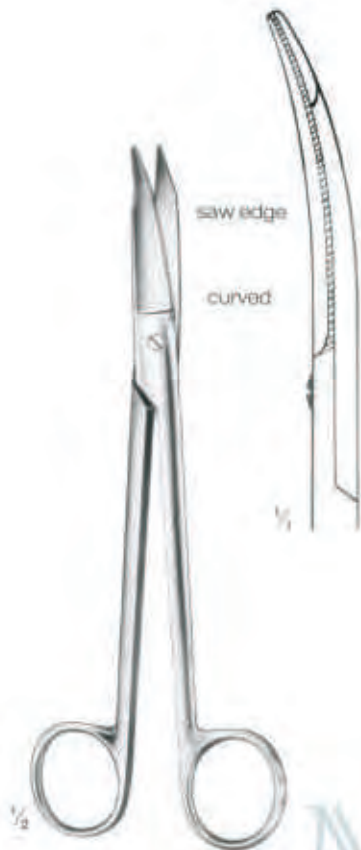

Martin
20 cm/8"
F-2113.20

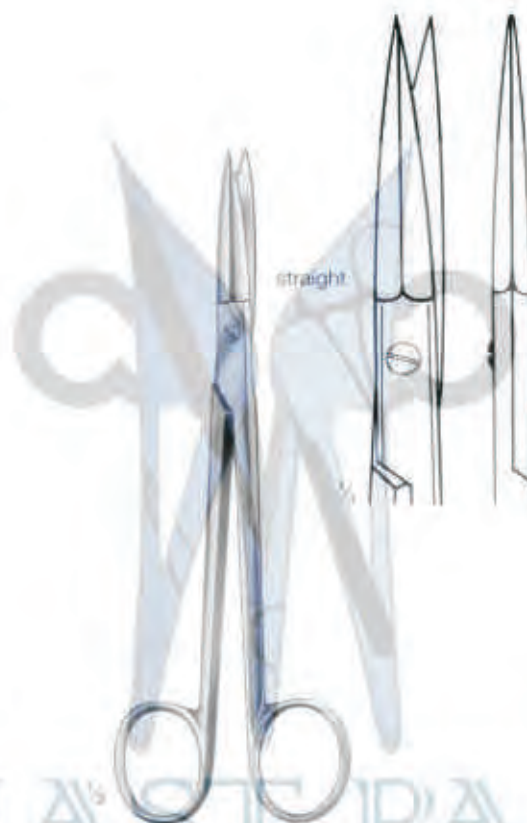

McIndoe
19 cm/7 1/2"
F-2120.19

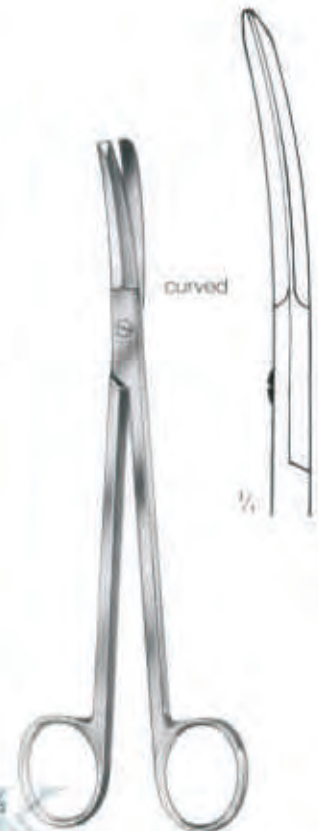

Potts-Smith
19 cm/7 1/2"
F-2135.19

MAST PAK
SURGICAL CORPORATION

Bandage scissors
Ciseaux pour pansements
Tijeras para vendajes



14.5 cm/5 7/8"
F-5314.



17.5 cm/6 7/8"
F-5317.



Universal
19 cm/7 1/2"
F-5319.

MAST PAK
SURGICAL CORPORATION

Bandage scissors
Ciseaux pour pansements
Tijeras para vendajes



Knowles
 14.5 cm/5 7/8"
 F-5330.14



Knowles (Hi-Level)
 14 cm/5 1/2"
 F-5331.14



Knowles (Bantam)
 14 cm/5 1/2"
 F-5333.14



Lister

cm	inch.	
9	3 1/2	F-5353.09
11	4 1/4	F-5353.11
14	5 1/2	F-5353.14
18	7	F-5353.18
20	8	F-5353.20



Esmarch

cm	inch.	
20	8	F-5365.20
22	8 1/2	F-5365.22



Bergmann
 23 cm/9"
 F-5369.23

MASTIPAK
 SURGICAL CORPORATION

Clothing scissors, plaster-of-paris shears
Cisailles pour pansements et appareils plâtrés
Tijeras para vestidos, Cizallas para vendajes enyesados

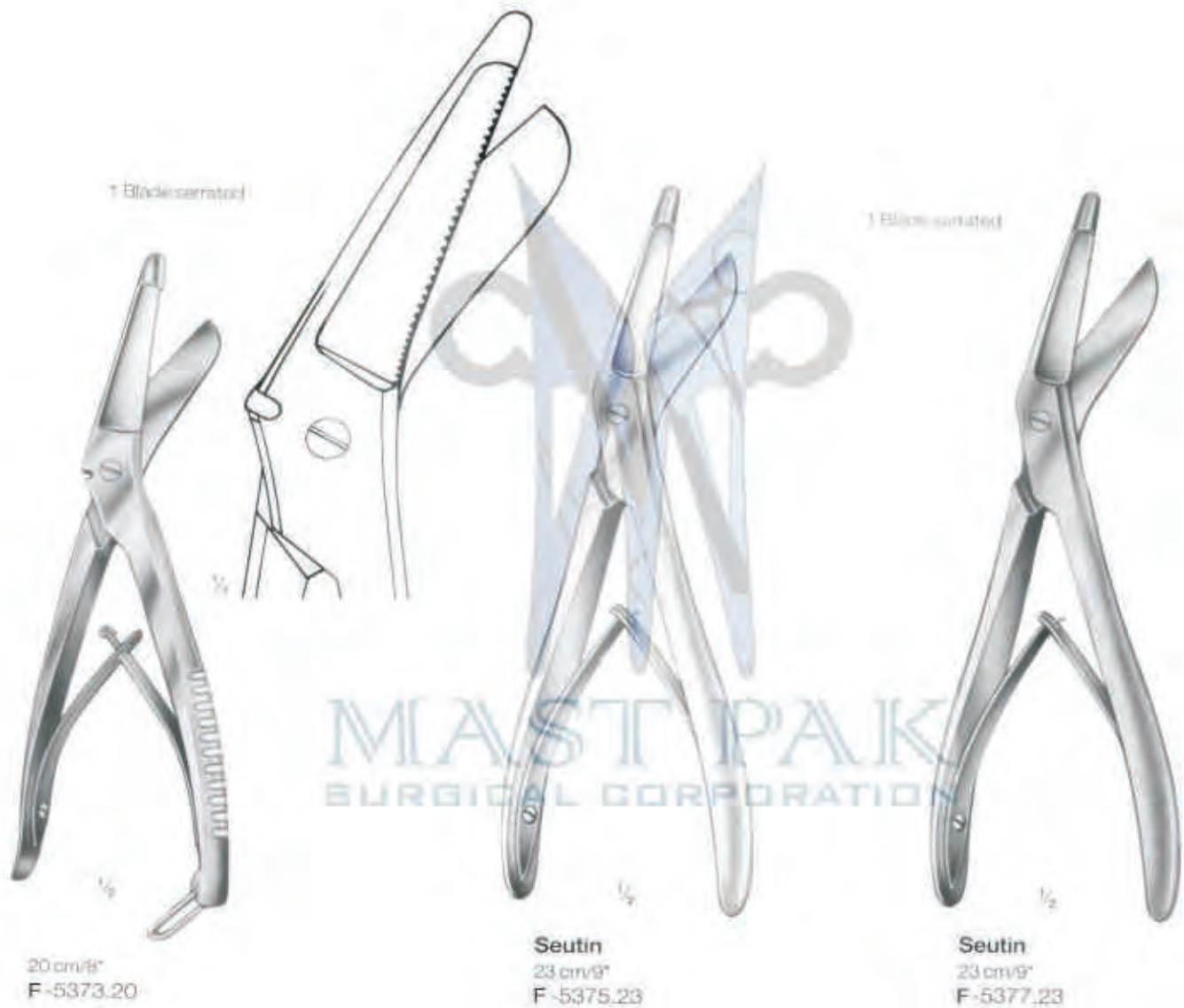

Plaster -of-paris shears
Cisailles pour appareils plâtrés
Cizallas para vendajes enyesados



Fistula scissors
Ciseaux pour fistules
Tijeras para fistulas



Kelly



16 cm/6 1/8"
 F-2084.16

straight



18 cm/7"
 F-2084.18



16 cm/6 1/8"
 F-2085.16

curved



18 cm/7"
 F-2085.18



F-2090.14
 straight



F-2091.14
 curved



F-2094.14
 straight



F-2095.14
 curved



Joseph
 14 cm/5 1/2"



Sanvenero
 14 cm/5 1/2"

MAST PEAK
 SURGICAL CORPORATION

Gum scissors
Ciseaux à gencives
Tijeras para encías



Locklin
16 cm/6 3/4"
F-3221.16

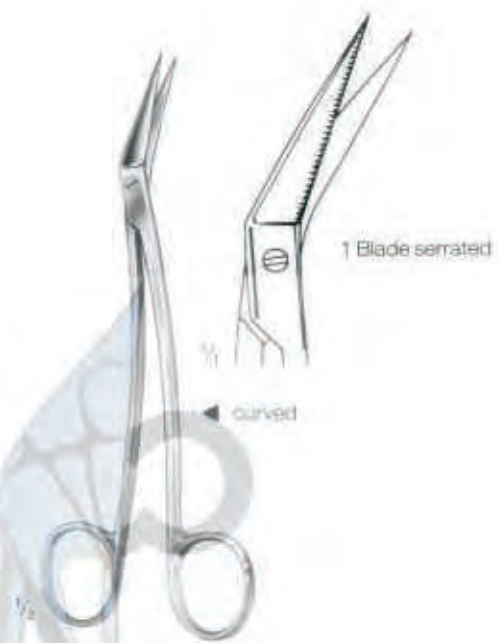

Locklin
16 cm/6 3/4"
F-3223.16



Quinby
12 cm/4 3/4"
F-3231.12



Chadwick
11 cm/4 3/8"
F-3239.11

MASTPAK
SURGICAL CORPORATION

Gum scissors
Ciseaux à gencives
Tijeras para encías

1 Blade serrated



Goldmann-Fox
13 cm/5"
F-3250.13

straight



1 Blade serrated



Goldmann-Fox
13 cm/5"
F-3251.13

curved



1 Blade serrated



Goldmann-Fox
13 cm/5"
F-3253.13

S-curved



MAST PAK
SURGICAL CORPORATION

Otology

Ear knives
Couteaux auriculaires
Cuchillos auriculares

Periosteal Knife



Muck
 13,5 cm/5 1/4"
 A-2010.13

Mastoid Knife



Politzer
 13,5 cm/5 1/4"
 A-2012.13



Brühl
 15 cm/6"
 A-2020.15



Brühl
 15 cm/6"
 A-2021.15

Furuncle Knife



Politzer
 16 cm/6 1/4"
 A-2028.16

Tympanum Knives



Jacobson
 15,5 cm/6 1/8"
 A-2030.15



Buck
 15 cm/6"
 A-2032.15



Fig. 1

Fig. 2



Fig. 1

Fig. 2

Sexton

straight	Fig.	curved
A-2040.01	1	A-2041.01
A-2040.02	2	A-2041.02

Ear knives and needles
Couteaux et aiguilles auriculaires
Cuchillos y agujas auriculares

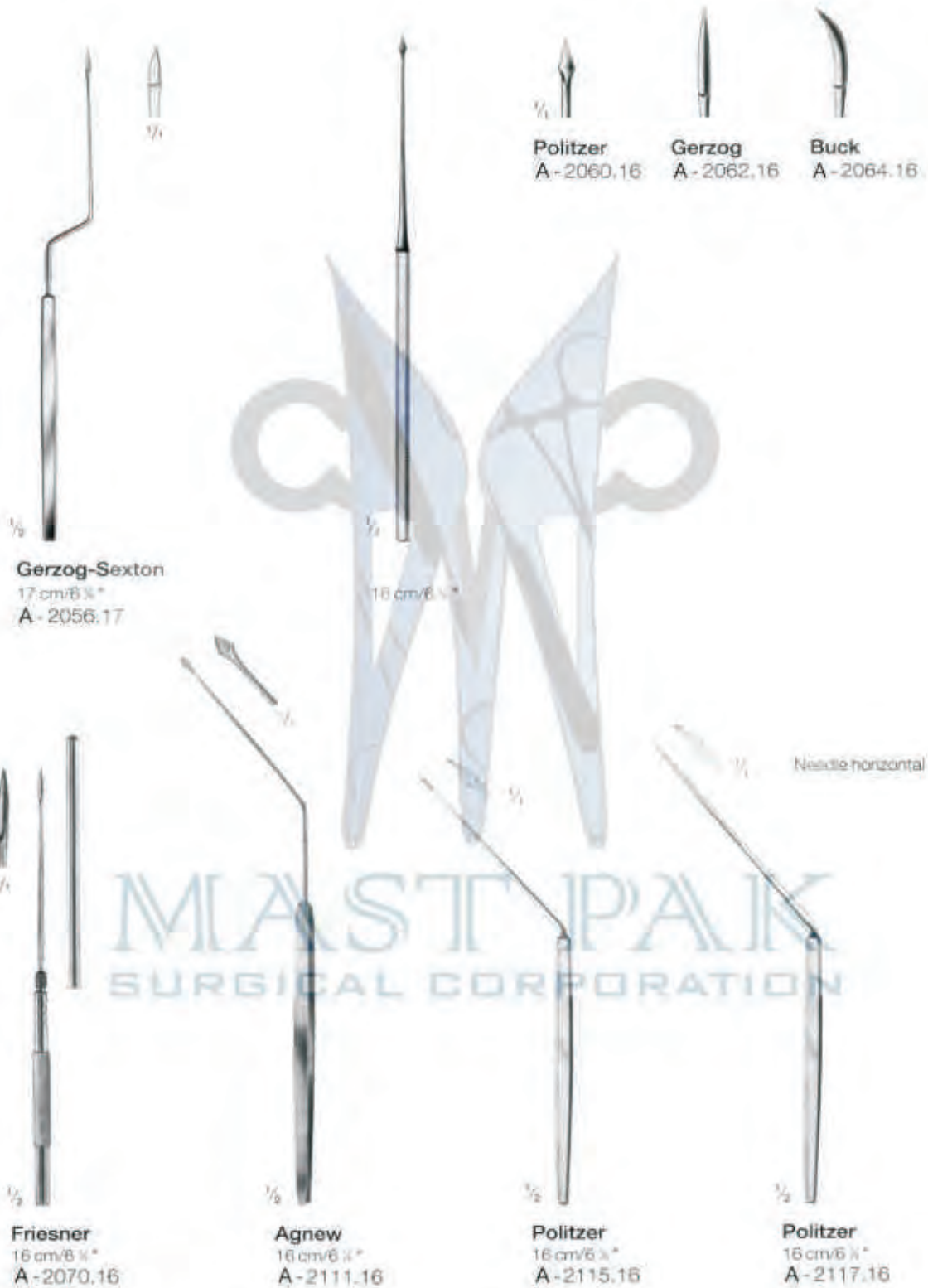

Ear knives and needles
Couteaux et aiguilles auriculaires
Cuchillos y agujas auriculares



Lucae
 18 cm/7 1/4"
 A-2125.18



Lucae
 18 cm/7 1/4"
 A-2127.18



Lucae
 18 cm/7 1/4"
 A-2129.18



Bayer
 10 cm/4"
 A-2135.10

Needle horizontal



Bayer
 10 cm/4"
 A-2137.10



Royce
 A-2151.01



Tip only



Royce
 A-2151.02



Sexton
 A-2151.03



Politzer
 A-2151.05

MAST PAK
 SURGICAL CORPORATION

Handle only



Royce
 A-2150.00



Royce
 A-2153.11



Royce
 A-2153.12



Sexton
 A-2153.13



Politzer
 A-2153.15

Wound and nerve hooks, ear hooklets
Crochets très fins et crochets à nerfs, crochets auriculaires
Ganchitos y ganchos para nervios, ganchitos auriculares

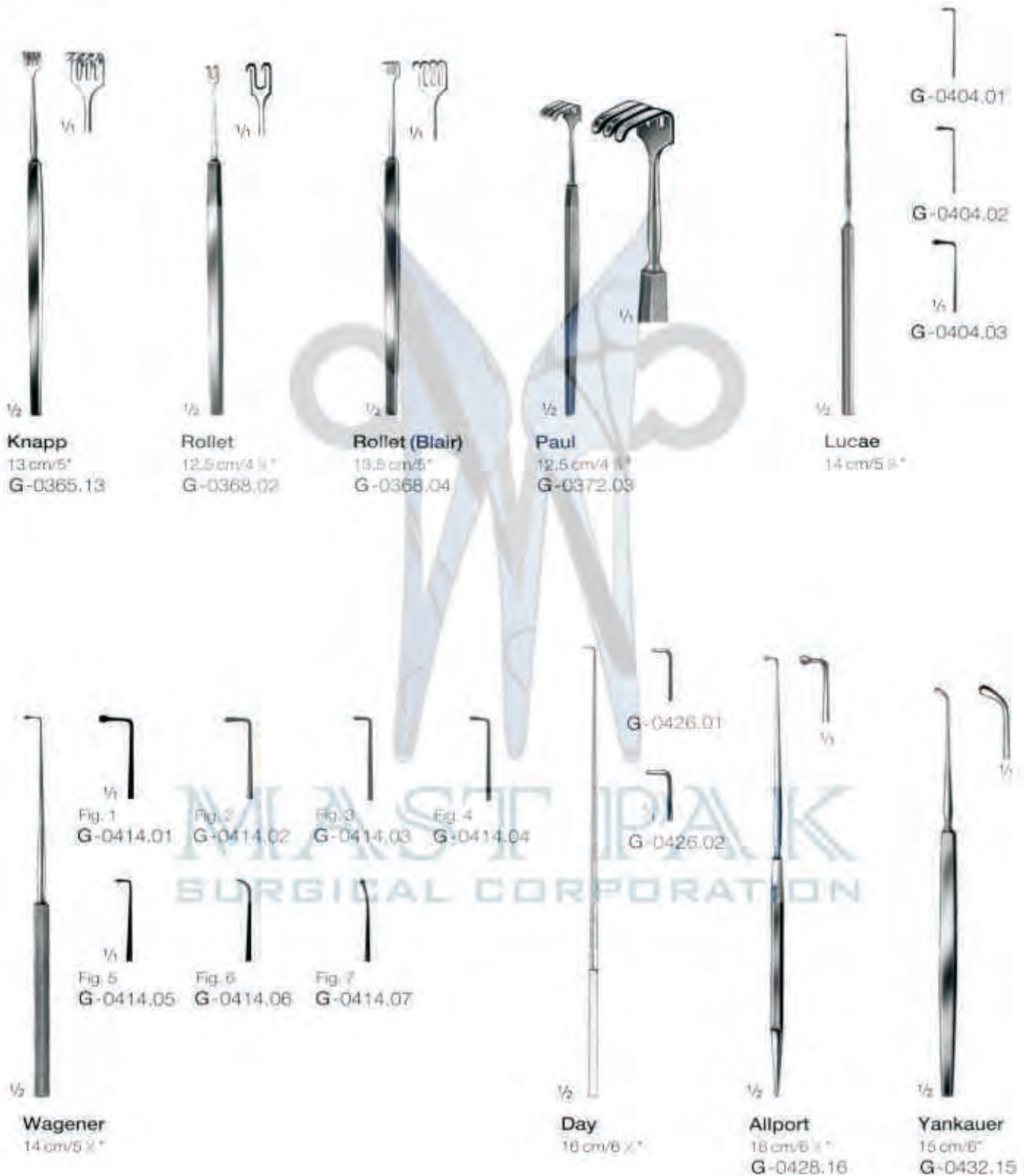

Ear specula Spéculums auriculaires Espéculos auriculares

for children



Hartmann

Pieces Fig.

① = Ø 2,0 mm
N-0130.20

② = Ø 3,5 mm
N-0130.35

③ = Ø 5,0 mm
N-0130.50

for adults



Hartmann

Pieces Fig.

② = Ø 3,5 mm
N-0130.35

③ = Ø 5,0 mm
N-0130.50

④ = Ø 6,5 mm
N-0130.65

⑤ = Ø 7,5 mm
N-0130.75

for adults



Politzer

Pieces Fig.

① = Ø 3,0 mm
N-0134.30

② = Ø 4,0 mm
N-0134.40

③ = Ø 5,0 mm
N-0134.50

Set of 3 1-3 N-0130.03

Set of 3 3-5 N-0131.03
4 2-5 N-0131.04

Set of 3 1-3 N-0134.03

for adults



Toybee

Pieces Fig.

① = Ø 3,0 mm
N-0136.30

② = Ø 4,0 mm
N-0136.40

③ = Ø 5,0 mm
N-0136.50

④ = Ø 6,5 mm
N-0136.65



N-0159.12

Metal Support for Specula

Set of 3 2-4 N-0136.03
4 1-4 N-0136.04

Loops, foreign body instruments, ear curettes
Anses, instruments à corps étrangers, curettes auriculaires
Asas, instrumentos para cuerpos extraños, curetas auriculares

Loops

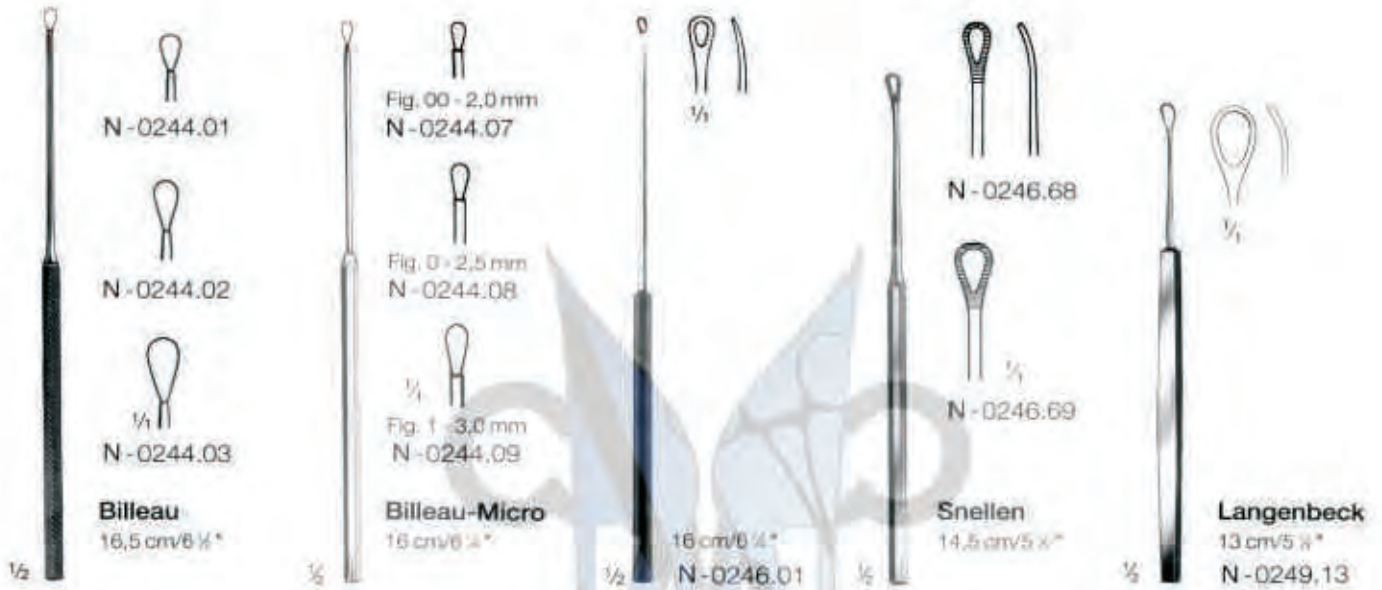

Mastoid Probe

Foreign Body Instruments



Ear Curettes

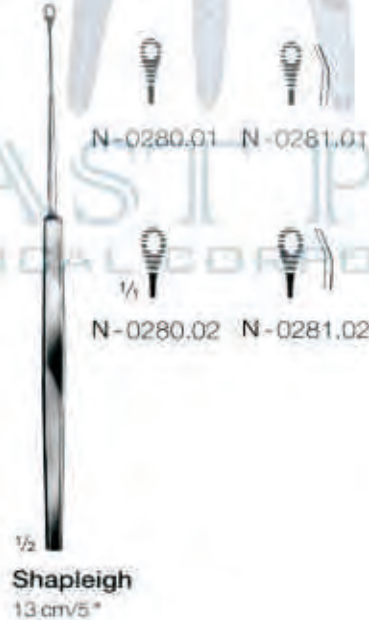

**Ear polypus snares,
Serre-noeuds auriculaires,
Polipótomos auriculares,**



Cannula only
N-0735.11
Wire Guide only
N-0735.12

1/2

Krause
18 cm/7"
N-0735.10



Cannula with Wire Guide, only

1/2

Krause-Voss
18 cm/7"
N-0735.20



Wire Guide only

1/2

Lange-Wilde
18 cm/7"
N-0735.30

MAST PAIK
SURGICAL CORPORATION

Foreign body levers, ear polypus forceps
Leviers pour corps étrangers, pinces pour polypes auriculaires
Elevadores para cuerpos extraños, pinzas para pólipos auriculares

Foreign Body Levers

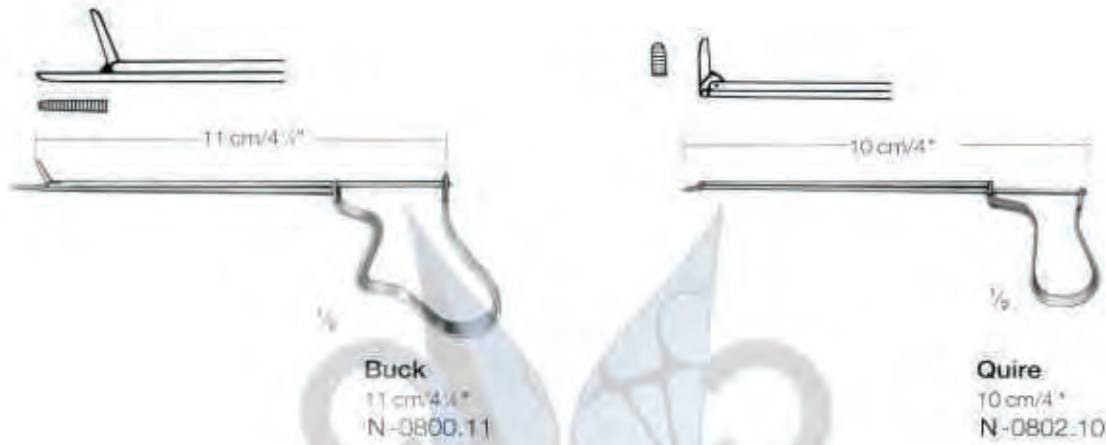

Buck
 11 cm/4 1/4"
 N-0800.11

Quire
 10 cm/4"
 N-0802.10

Ear Polypus Forceps, Tampon Forceps



Hartmann
 5.5 cm/2 1/8"
 N-0810.13

Hartmann
 5.5 cm/2 1/8"
 N-0812.13

Tilley (Yankauer)
 6 cm/2 3/8"
 N-0821.14

MAST PAK
 SURGICAL CORPORATION

Ear polypus forceps, tampon forceps
Pincas pour polypes auriculaires, pincas porte-tampons
Pinzas para pólipos auriculares y para taponamientos

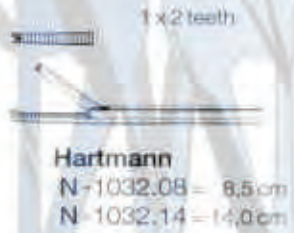

MASTIPAK
SURGICAL CORPORATION

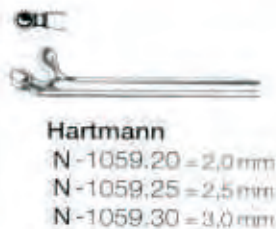

Mastoid punches
Pinces emporte-pièces
Pinzas cortantes para huesos

Fig. 0  3x3mm N-3177.03



Fig. 1  4x4mm N-3177.04

Fig. 2  5x6mm N-3177.05

Fig. 3  6x6mm N-3177.06



 1mm N-1106.10

 2mm N-1106.20

 3mm N-1106.30

MAST PAK
 SURGICAL CORPORATION

 1mm N-1109.10

 2mm N-1109.20

Atticus Punch



Mallets
Maillets
Martillos y mazos



Hemostats, chisels, gouges, osteotomes
Fouloirs hémostatiques, ciseaux-burins, gouges, ostéotomes
Hemostáticos, cineles, gubias, osteótomos

2 mm	3 mm			
J-1004.02	J-1004.03			
4 mm	5 mm			
J-1004.04	J-1004.05			
6 mm	8 mm			
J-1004.06	J-1004.08			
9 mm	10 mm			
J-1004.09	J-1004.10			
1/2		1/2	1/2	
16 cm/6 1/8"		13,5 cm/5 1/8"	13,5 cm/5 1/8"	13,5 cm/5 1/8"
		J-1020.04	J-1022.04	J-1024.04
		4 mm	4 mm	4 mm
		J-1020.06	J-1022.06	J-1024.06
		6 mm	6 mm	6 mm
		J-1020.08	J-1022.08	J-1024.08
		8 mm	8 mm	8 mm
		J-1020.10	J-1022.10	J-1024.10
		10 mm	10 mm	10 mm
		J-1020.12	J-1022.12	J-1024.12
		12 mm	12 mm	12 mm
		J-1020.14	J-1022.14	J-1024.14
		14 mm	14 mm	14 mm
		J-1020.16	J-1022.16	J-1024.16
		16 mm	16 mm	16 mm

1/2	1/2	1/2	1/2	
13,5 cm/5 1/8"	17 cm/6 3/4"	13,5 cm/5 1/8"	17 cm/6 3/4"	
J-1062.02	J-1072.02	J-1064.02	J-1074.02	
2 mm	2 mm	2 mm	2 mm	
J-1062.03	J-1072.03	J-1064.03	J-1074.03	
3 mm	3 mm	3 mm	3 mm	
J-1062.04	J-1072.04	J-1064.04	J-1074.04	
4 mm	4 mm	4 mm	4 mm	
J-1062.05	J-1072.05	J-1064.05	J-1074.05	
5 mm	5 mm	5 mm	5 mm	
J-1062.06	J-1072.06	J-1064.06	J-1074.06	
6 mm	6 mm	6 mm	6 mm	
J-1062.07	J-1072.07	J-1064.07	J-1074.07	
7 mm	7 mm	7 mm	7 mm	
J-1062.08	J-1072.08	J-1064.08	J-1074.08	
8 mm	8 mm	8 mm	8 mm	

Chisels, gouges, with ferrozell (novotex) handles
Ciseaux-burins, gouges, manche en ferrozell (novotex)
Cinceles, gubias, con mangos de ferrozell (novotex)



Mini-Lexer
18 cm/7"



Mini-Lexer
18 cm/7"



Lexer
22 cm/8 3/4"

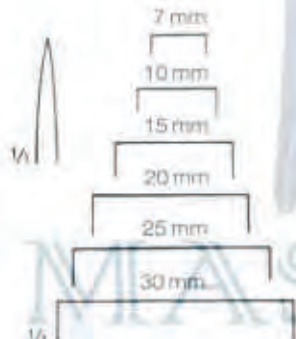

J-1160.07	7 mm
J-1160.10	10 mm
J-1160.15	15 mm
J-1160.20	20 mm
J-1160.25	25 mm
J-1160.30	30 mm



Lexer
22 cm/8 3/4"

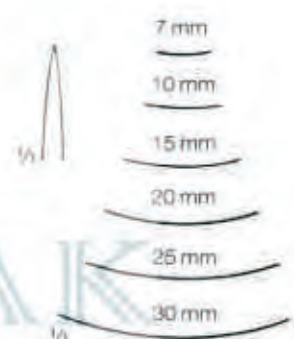

J-1164.07	7 mm
J-1164.10	10 mm
J-1164.15	15 mm
J-1164.20	20 mm
J-1164.25	25 mm
J-1164.30	30 mm

Bone curettes
Curettes tranchantes
Cucharillas cortantes



Bone curettes Curettes tranchantes Cucharillas cortantes

Lupus Curettes



oval/oval

1/2
1/4
Volkmann



round/oval

1/2
1/4
Volkmann



1/2
Wolff
14 cm/5 1/4"



Fig. 1
J-2264.01



2
J-2264.02



3
J-2264.03



4
J-2264.04



5
J-2264.05



6
J-2264.06

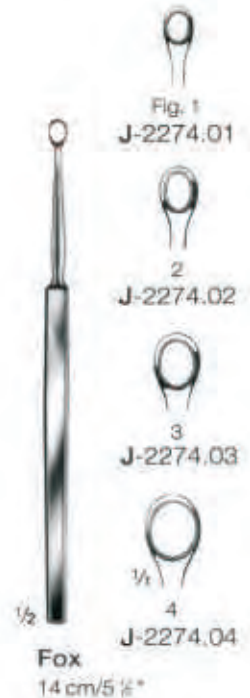

1/2
Fox
14 cm/5 1/2"

cm	inch		
13	5	J-2310.13	J-2314.13
14.5	5 3/4	J-2310.14	
16	6 1/4		J-2314.16
17	6 3/4	J-2310.17	
20	8	J-2310.20	J-2314.20



1/4
1/2
1/4
Williger
13.5 cm/5 1/4"

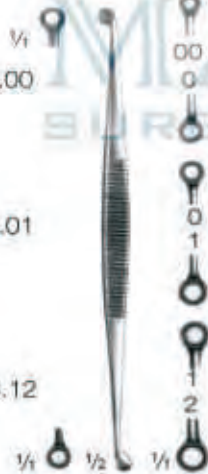

1/4
1/2
1/4
Martini
13.5 cm/5 1/4"



1/2
1/4
Jansen
21 cm/8 1/4"
J-2340.21



1/2
1/4
Jansen
16 cm/6 1/4"
J-2344.16



1/2
1/4
Jacobson
13 cm/5 1/4"
J-2346.13



1/2
1/4
Jansen
15 cm/6"
J-2349.15

MASTIC PAIK
SURGICAL CORPORATION

Chisels and gouges for rhinology and plastic operations
Ciseaux-burins et gouges pour Rhinologie et pour opérations plastiques
Cinceles y gubias para Rinología y para operaciones plásticas

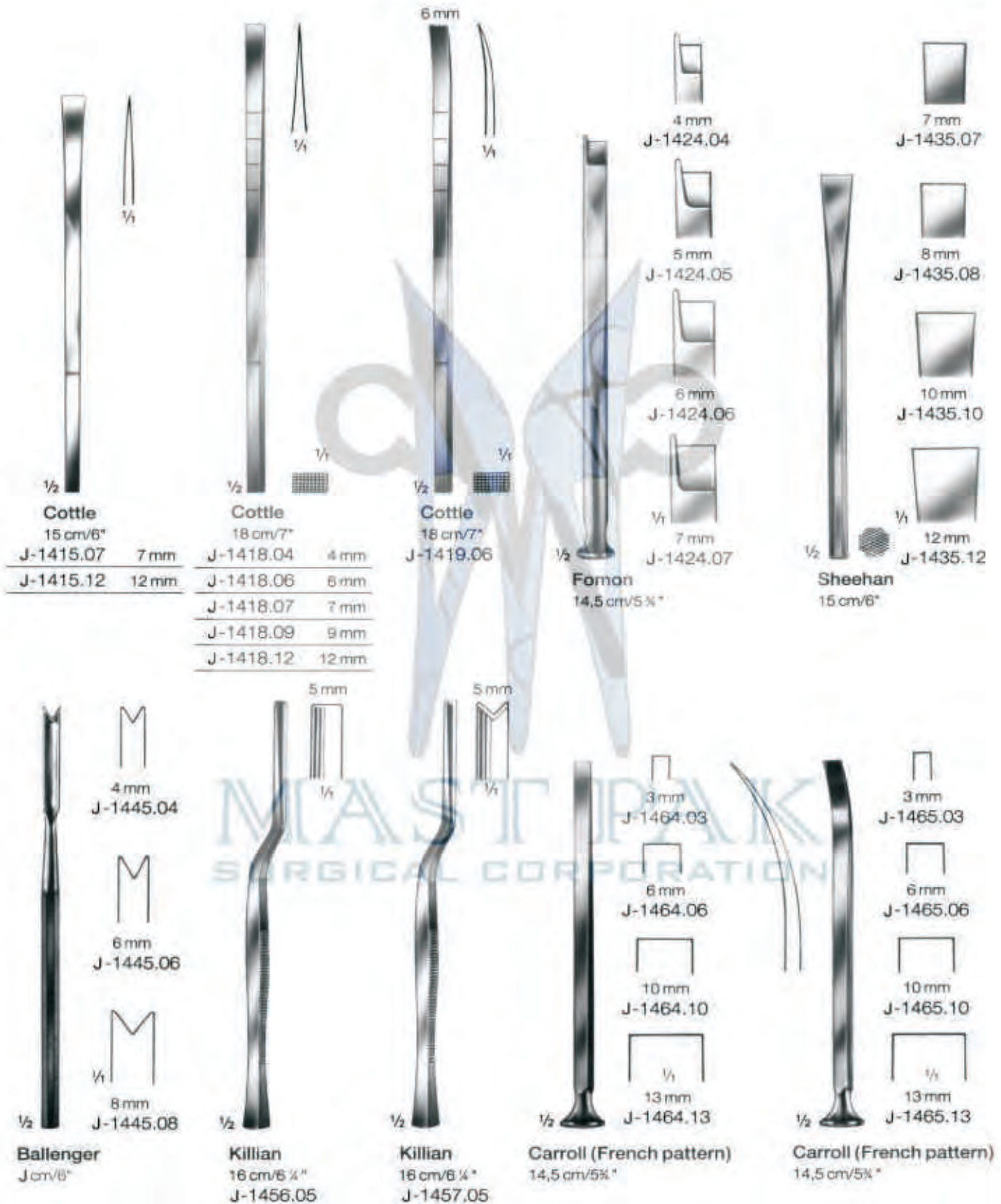

Periosteotomes, chisels and gouges
 Périostotomes, ciseaux-burins et gouges
 Periostótomos, cinceles y gubias

Cisels for oral and maxillo-facial surgery
 Ciseaux-burins pour la chirurgie buccale et maxillo-faciale
 Osteótomos para cirugía bucal y maxilo-facial



Self - retaining retractors
Ecarteurs autostatiques
Separadores autostáticos

4 x 4 teeth sharp



Jansen
 10 cm/4"
 G-5310.11

4 x 4 teeth blunt



Jansen
 10 cm/4"
 G-5311.11

3 x 3 teeth sharp



Jansen
 10.5 cm/4 1/8"
 G-5312.11

3 x 3 teeth blunt



Jansen
 10.5 cm/4 1/8"
 G-5313.11

sharp



Plester
 13 cm/5"
 G-5363.22

blunt



Plester
 13 cm/5"
 G-5363.32

blunt



Plester
 11 cm/4 3/8"
 G-5371.02

blunt



Plester
 11 cm/4 3/8"
 G-5371.01

MASTIPAK
 SURGICAL CORPORATION

Self - retaining retractors
Ecarteurs autostatiques
Separadores autostáticos

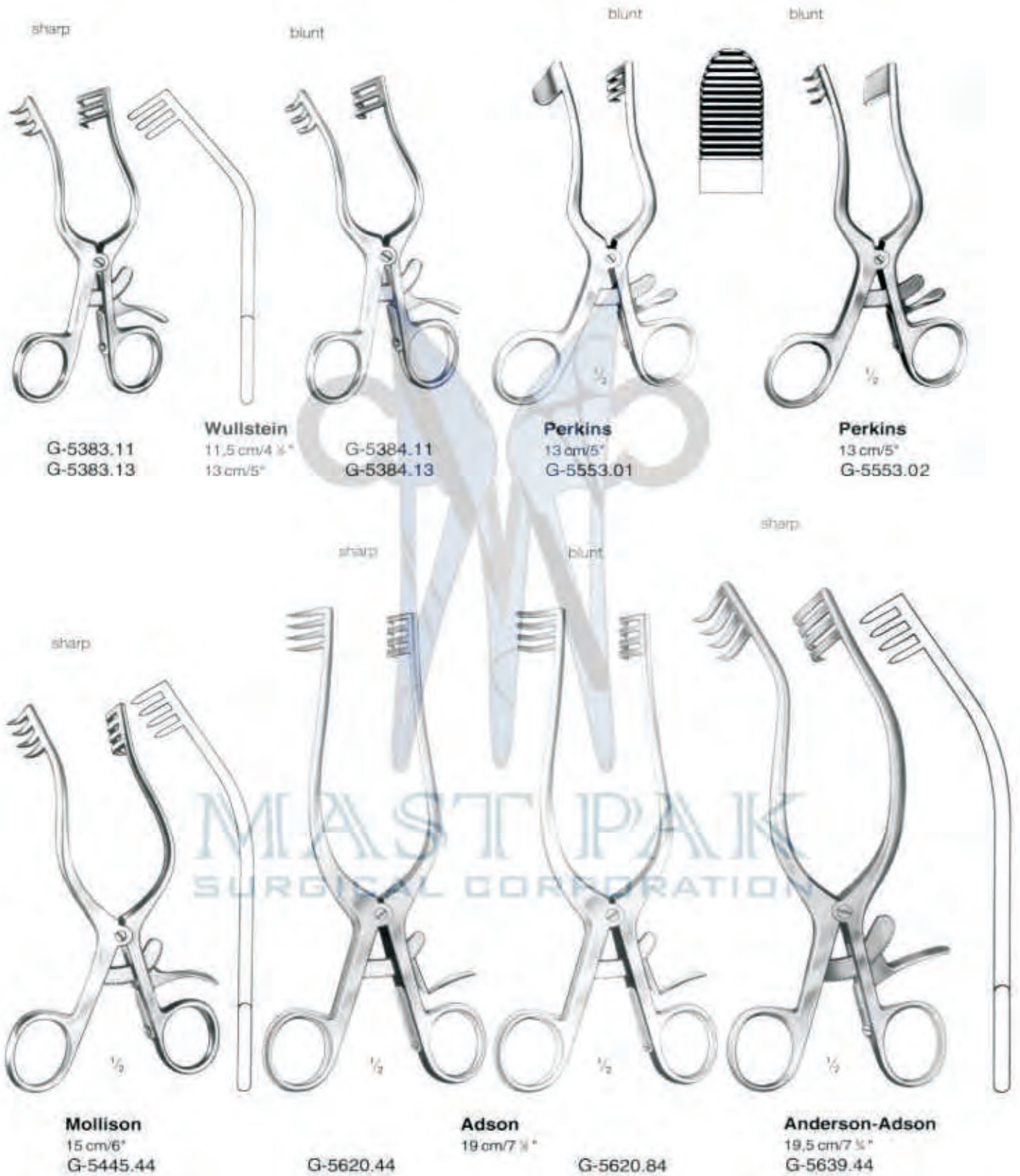

Bone rongeurs
Pinces-gouges
Pinzas-gubias



Stellbrink
 17 cm/6 3/4"

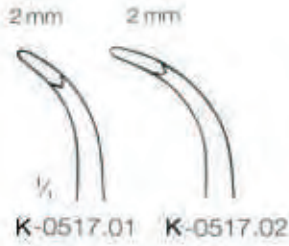

K-0517.01 K-0517.02



Kleinert-Kutz
 14 cm/5 1/2"

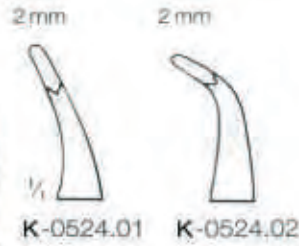

K-0524.01 K-0524.02



Mini-Friedman
 12.5 cm/4 3/4"
 K-0531.12

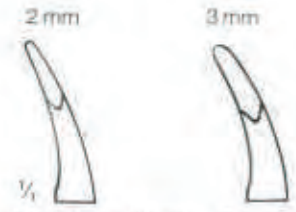

Friedman
 14 cm/5 1/2"
 K-0533.14



Mead
 17 cm/6 3/4"
 K-0561.17



Blumenthal
 16 cm/6 1/4"



K-0576.30 K-0576.45 K-0576.90



Bane-Hartmann
 17 cm/6 3/4"
 K-0589.17



MILASTOPAIK
 SURGICAL CORPORATION

Bone rongeurs
Pinces-gouges
Pinzas-gubias

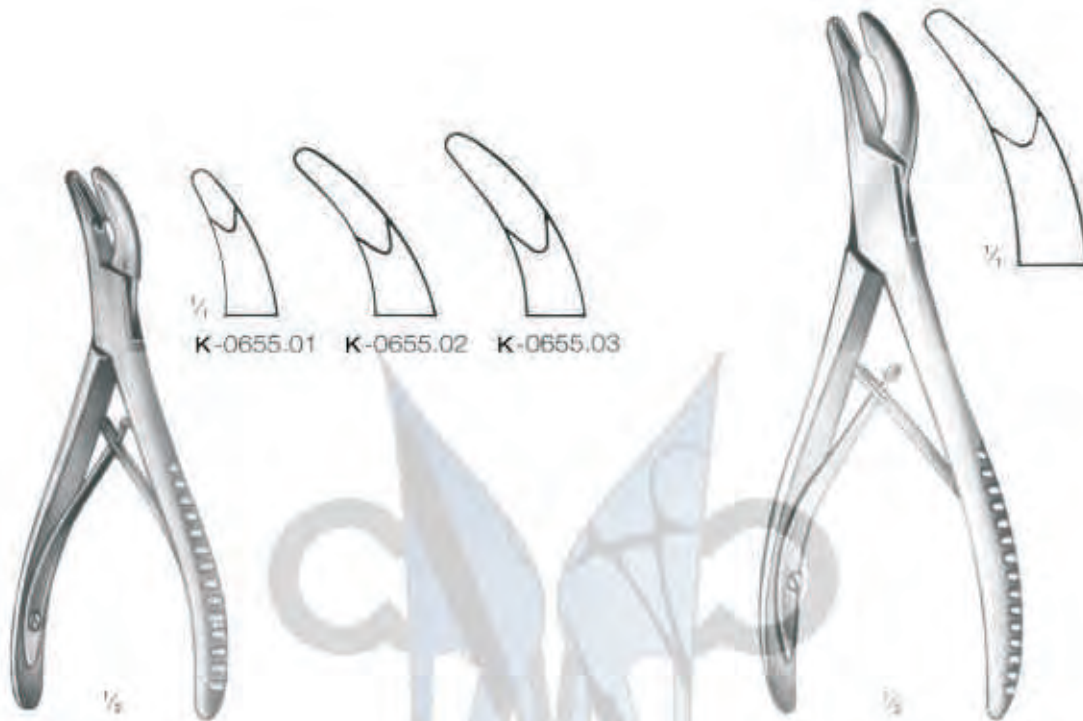

Luer
 15 cm/6"

Olivecrona
 20 cm/8"
 K-0677.20



Böhler (Ruskin-Mini)
 15 cm/6"

Beyer
 18 cm/7"
 K-1011.18

Zaufal-Jansen
 18 cm/7"
 K-1013.18

Bone cutting forceps
Pinces coupantes
Pinzas cortantes para huesos

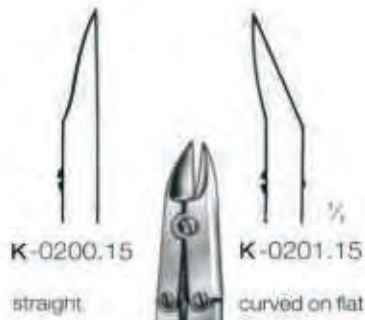

Böhler
 15 cm/6"

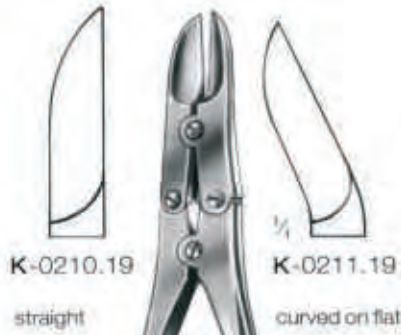

Ruskin-Liston
 19 cm/7 1/2"



McIndoe
 18 cm/7"
 K-0223.17

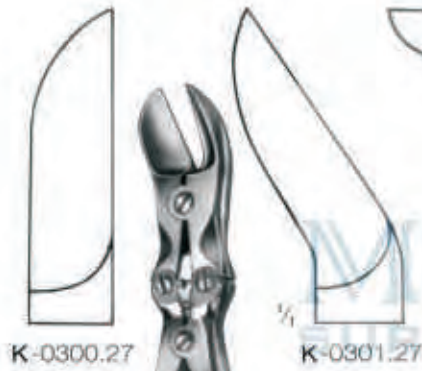

Stille-Liston
 27 cm/10 3/4"



Stille-Liston
 26 cm/10 1/4"
 K-0303.26



Liston-Key-Horsley
 27 cm/10 3/4"
 K-0305.27



Semb
 23 cm/9"
 K-0307.23

Raspatories
Raspatoires
Periostótomos



Raspatories
Raspatoires
Periostótomos



Diagnostics Diagnostic Diagnostico

c 128
 c 128 O-0010.31
 c¹ 256 O-0010.32
 c² 512 O-0010.33
 c³ 1024 O-0010.34
 c⁴ 2048 O-0010.35
 c⁵ 4096 O-0010.37



Hartmann

c 128
 c 128 O-0020.41
 c¹ 256 O-0020.42
 c² 512 O-0020.43
 c³ 1024 O-0020.44
 c⁴ 2048 O-0020.45
 c⁵ 4096 O-0020.46



Lucae



Hartmann
 O-0011.81

Set of 5 Tuning Forks
 consisting of:

c 128 O-0010.31
 c¹ 256 O-0010.32
 c² 512 O-0010.33
 c³ 1024 O-0010.34
 c⁴ 2048 O-0010.35



French
 C₁ 16
 O-0025.01



French
 C₁ 32
 O-0025.02



Hartmann
 C 64
 O-0025.03



Hartmann
 c 128
 O-0025.04



Hartmann
 c¹256
 O-0025.05

MAST PAK
 SURGICAL CORPORATION

Diagnostics
Diagnostic
Diagnostico



Ziegler
Head Mirrors
O-3020.09 90 mm Ø
O-3020.10 100 mm Ø

MAST PAK
SURGICAL CORPORATION

Micro EAR Instruments

Ear specula, micro ear curettes and spoons
Spéculums et microcurettes auriculaires
Espéculos, micro-curetas y micro-cucharillas auriculares



Holmgren



5 mm Ø
N-2072.50



8 mm Ø
N-2072.60



7 mm Ø
N-2072.70



Richnau-Holmgren



3 mm Ø
N-2074.30



5 mm Ø
N-2074.50



7 mm Ø
N-2074.70

sharp



1/2

blunt



1/2

- 0000
- 000
- 00
- 0
- 0
- †
- 1/4

Buck-Wullstein-Micro

16 cm/6 1/4"

N-2110.24	Fig. 0000	0,9 mm Ø	N-2111.24
N-2110.33	Fig. 000	1,1 mm Ø	N-2111.33
N-2110.42	Fig. 00	1,3 mm Ø	N-2111.42
N-2110.50	Fig. 0	1,8 mm Ø	N-2111.50
N-2110.51	Fig. †	2,1 mm Ø	N-2111.51

Ø = inside diameter



1,5 x 2,5 mm

1/2

Shea

16 cm/6 1/4"
N-2152.15



1,5 x 2,5 mm

1/2

Shea

16 cm/6 1/4"
N-2153.15

Micro ear cures and spoons
Microcurettes auriculaires
Micro-curetas y micro-cucharillas auriculares



House
 15 cm/6"
 N-2210.12 = 1,0/1,2 mm
 N-2215.18 = 1,5/1,8 mm
 slightly angled



House
 15 cm/6"
 N-2211.12 = 1,0/1,2 mm
 N-2216.18 = 1,5/1,8 mm
 strongly angled



House
 17 cm/6 3/4"
 N-2217.01 = 1,5/1,8 mm = N-2217.02
 slightly angled strongly angled

Micro needles and hooklets
Micro-aiguilles et crochets
Micro-agujas y ganchitos



Barbara
 N-2300.01

Needle, straight, sharp point



N-2300.03

Needle, light curve, sharp point



Rosen
 N-2300.06

Needle, strong curve, sharp point



Shambaugh
 N-2325.04 = 0,4 mm
 N-2325.06 = 0,6 mm
 N-2325.08 = 0,8 mm
 N-2325.10 = 1,0 mm

Hooklets, angled



Shambaugh
 N-2345.04 = 0,4 mm
 N-2345.06 = 0,6 mm
 N-2345.08 = 0,8 mm
 N-2345.10 = 1,0 mm
 N-2345.12 = 1,2 mm
 N-2345.15 = 1,5 mm
 N-2345.20 = 2,0 mm
 N-2345.25 = 2,5 mm

Hooklets, angled



Shambaugh
 N-2390.04 = 0,4 mm
 N-2390.06 = 0,6 mm
 N-2390.08 = 0,8 mm
 N-2390.10 = 1,0 mm
 N-2390.12 = 1,2 mm
 N-2390.15 = 1,5 mm
 N-2390.20 = 2,0 mm
 N-2390.25 = 2,5 mm

Hooklets, angled



N-2426.06 = 0,6 mm

Hooklets, retrograde



N-2429.10 = 1,0 mm
 N-2429.25 = 2,5 mm

Hooklets, retrograde



Plester
 N-2445.16

Antrum Hooklet, blunt



16 cm 6 1/2 *

Micro needles/ picks and hooklets with angled shafts
Micro-aiguilles et crochets à tige coudée
Micro-agujas y ganchitos con vástago acodado



Needle, straight, sharp point



Needle, strong curve, sharp point

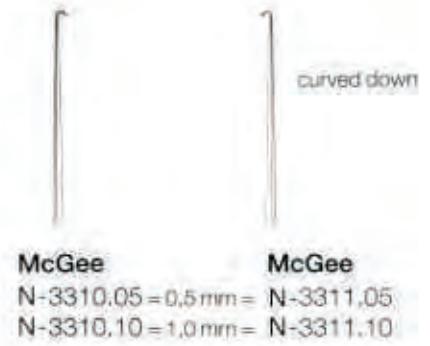

Footplate Hooks:

Micro Hooks/Picks, angled up

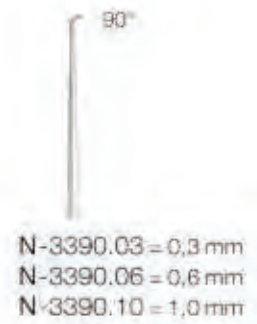
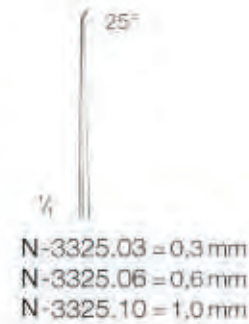

Micro Hooks/Picks, angled down

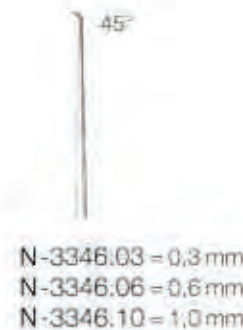
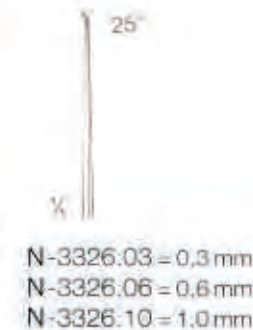

16 cm/6 1/4"

Knives for ear microsurgery

Couteaux pour la microchirurgie de l'oreille

Cuchillos para la microcirugía del oído



Respatories and elevators for ear microsurgery
Rugines et décolleurs pour la microchirurgie de l'oreille
Legras y elevadores para la microcirugía del oído

Respatories



Malleus and crura nippers
Pinces pour la malléole et la crurotomie
Pinzas para la cabeza del martillo y para la crurotomía

Malleus Nippers:

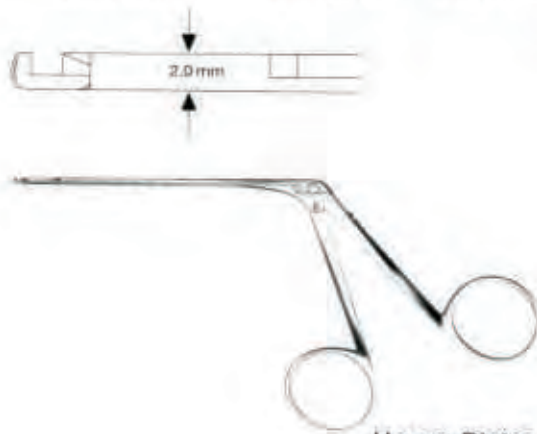
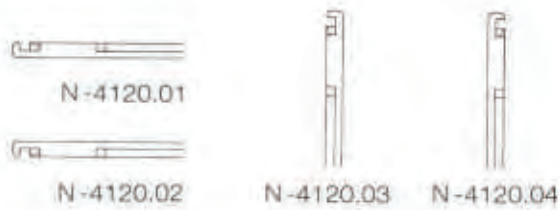

House-Dieter

Crura Nippers

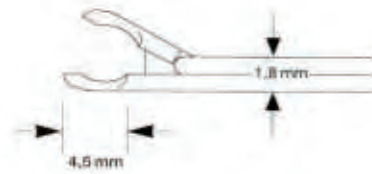
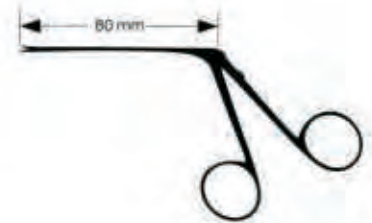

Tabb
N-4130,45

Crura Nippers



left cutting

Fisch
N-4133.01

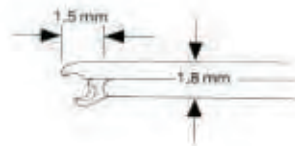

right cutting

Fisch
N-4132.01



Wire crimpers, forceps for holding and inserting middle ear prothesis and drain tubes
Pinces plieuses et instruments pour inserer les prothèses pour l'oreille interne et les drains tubulaires
Pinzas para doblar alambre, pinzas para coger e introducir prótesis para el oído interno y tubitos de drenaje

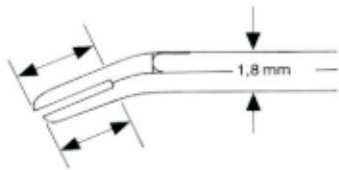

0,8 x 3,5 mm N-4208.35

0,8 x 6,0 mm N-4208.60



McGee

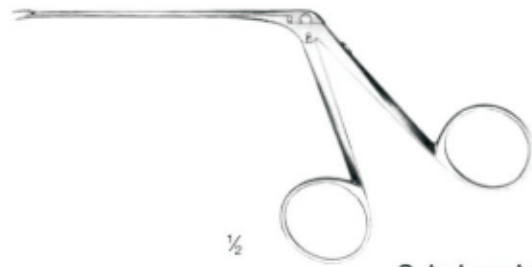
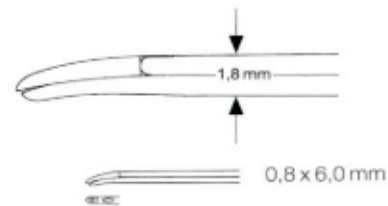
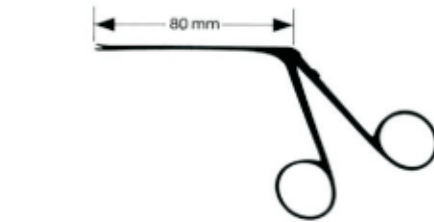

Schuknecht
N-4218.60

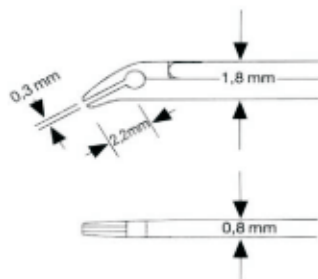

Fisch
N-4210.01

Wire crimpers, forceps for holding and inserting middle ear prosthesis and drain tubes
Pinces plieuses et instruments pour inserer les prothèses pour l'oreille interne et les drains tubulaires
Pinzas para doblar alambre, pinzas para coger e introducir prótesis para el oído interno y tubitos de drenaje

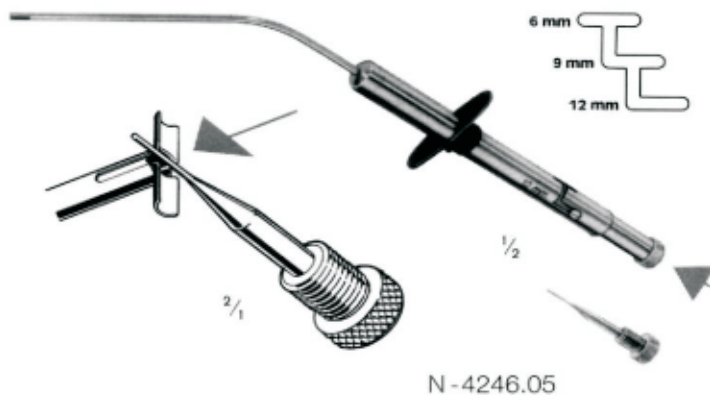

N -4246.05
 T-Tube Inserter
 adjustable in 6, 9 and 12 mms

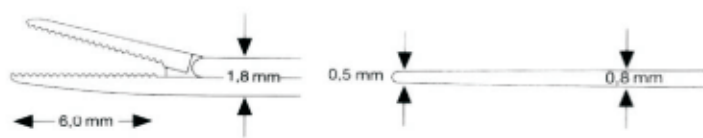

N -4242.06

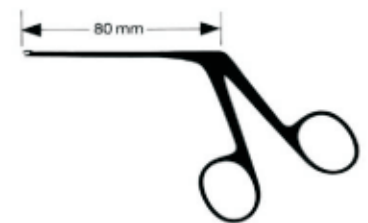

N -4242.08

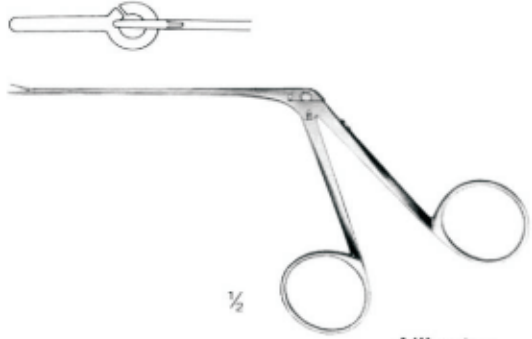
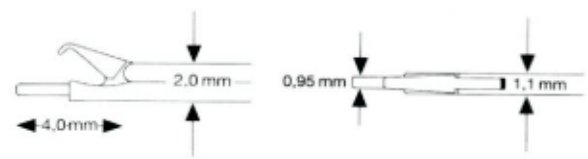

Alligator
 delicate
 N -4242.##

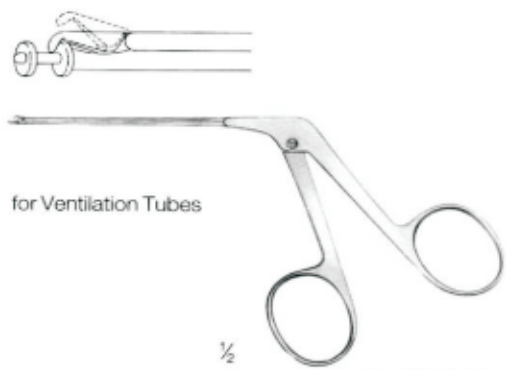





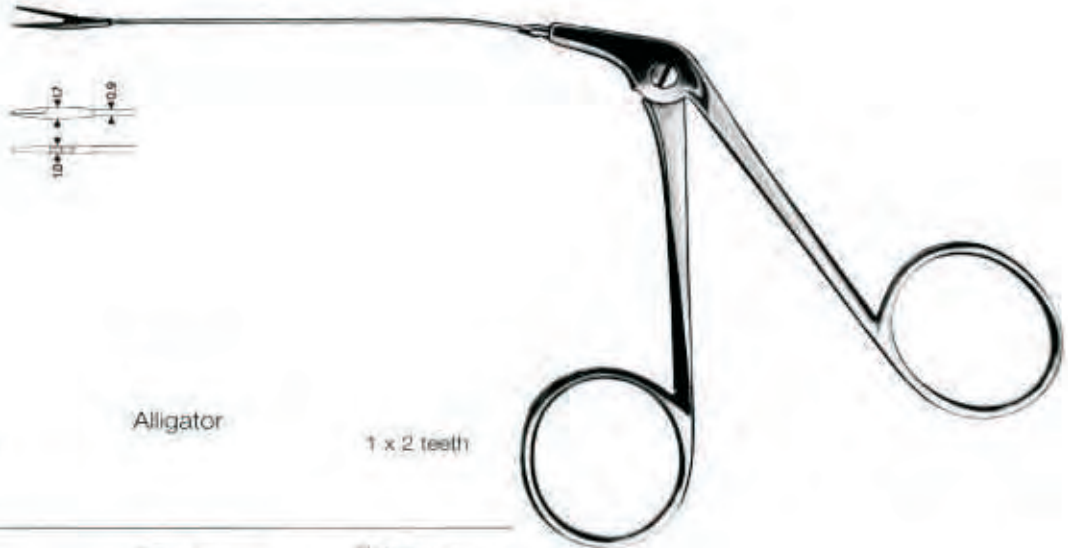



for Ventilation Tubes
 N -4244.05

Micro ear forceps with tubular shafts
Micropinces auriculaires à tige tubulaire
Micro-pinzas auriculares con vástago tubular



grasping Alligator 1 x 2 teeth

	grasping	Alligator	1 x 2 teeth
straight	 N-4720.05	 N-4722.05	 N-4723.22
angled up	 N-4720.50	 N-4722.50	 N-4723.58
curved left	 N-4720.54	 N-4722.54	
curved right	 N-4720.55	 N-4722.55	

Delicate Cup-shaped Forceps

straight	 N-4724.02	 N-4726.02
angled up	 N-4724.50	 N-4726.50
curved left	 N-4724.54	 N-4726.54
curved right	 N-4724.55	 N-4726.55

Micro ear forceps with tubular shafts
Micropinces auriculaires à tige tubulaire
Micro-pinzas auriculares con vástago tubular



Delicate Cup-shaped Forceps

	Ø 1 mm	Ø 1,5 mm	Ø 2 mm	Ø 2,5 mm	oval
straight	N-4910.02	N-4915.02	N-4920.02	N-4925.02	N-4933.02
angled up	N-4910.50	N-4915.50	N-4920.50	N-4925.50	N-4933.50
curved left	N-4910.54	N-4915.54	N-4920.54	N-4925.54	N-4933.54
curved right	N-4910.55	N-4915.55	N-4920.55	N-4925.55	N-4933.55

Micro ear scissors with tubular shafts
Microciseaux auriculaires à tige tubulaire
Micro-tijeras auriculares con vástago tubular



straight  N-5020.03

angled up  N-5020.33

curved left  N-5020.53

curved right  N-5020.63

straight  horizontal N-5020.73

angled up  N-5020.77



straight  N-5022.03

angled up  N-5022.33

curved left  N-5022.53

curved right  N-5022.63

straight  horizontal N-5022.73

angled up  N-5022.77

mini-micro

Micro ear scissors, bellucci-type, alligator action
Microciseaux auriculaires de bellucci, tige coulissante
Microtijeras auriculares según bellucci, vástago corredizo

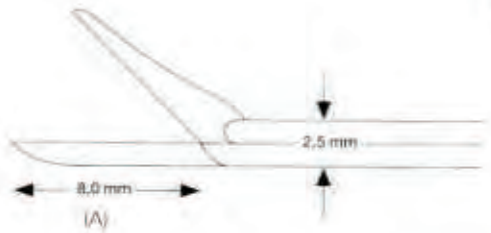

straight
 sharp/blunt sharp/sharp
 delicate
 N-4618.02 N-4618.03

curved up
 sharp/sharp
 N-4618.33 (A=6.0 mm)

curved to left
 sharp/sharp
 N-4618.53

curved to right
 sharp/sharp
 N-4618.63

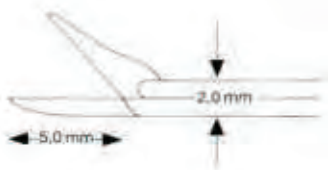

very delicate
 N-4625.02 N-4625.03

N-4625.33 (A=4.5 mm)

N-4625.53

N-4625.63

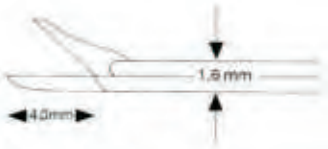

extra delicate
 N-4634.02 N-4634.03

N-4634.53

N-4634.63

Suction tubes
Tubes d'aspiration
 Tubos aspiradores



Vessel irrigating cannulas, malleable, silver plated

Schmid LLA
 15 cm/6"



13 cm/5"
 B-2353.20 = 2,0 mm \varnothing
 B-2353.27 = 2,7 mm \varnothing
 B-2353.33 = 3,3 mm \varnothing
 B-2353.40 = 4,0 mm \varnothing

17 cm/6 $\frac{1}{8}$ "
 B-2357.20 = 2,0 mm \varnothing
 B-2357.27 = 2,7 mm \varnothing
 B-2357.33 = 3,3 mm \varnothing
 B-2357.40 = 4,0 mm \varnothing



Frazier

13 cm/5"
 B-2363.20 = 2,0 mm \varnothing
 B-2363.27 = 2,7 mm \varnothing
 B-2363.33 = 3,3 mm \varnothing
 B-2363.40 = 4,0 mm \varnothing

17 cm/6 $\frac{1}{8}$ "
 B-2367.20 = 2,0 mm \varnothing
 B-2367.27 = 2,7 mm \varnothing
 B-2367.33 = 3,3 mm \varnothing
 B-2367.40 = 4,0 mm \varnothing



Frazier

13 cm/5"
 B-2373.20 = 2,0 mm \varnothing
 B-2373.27 = 2,7 mm \varnothing
 B-2373.33 = 3,3 mm \varnothing
 B-2373.40 = 4,0 mm \varnothing

17 cm/6 $\frac{1}{8}$ "
 B-2377.20 = 2,0 mm \varnothing
 B-2377.27 = 2,7 mm \varnothing
 B-2377.33 = 3,3 mm \varnothing
 B-2377.40 = 4,0 mm \varnothing



Fergusson

Suction tubes
Tubes d'aspiration
 Tubos aspiradores



L = 9 cm / 3 1/8"				L = 18 cm / 7"			
Suction tube mm Ø	x	Irrigation tube mmØ		Suction tube mm Ø	x	Irrigation tube mmØ	
0,9	x	0,7	B-2409.09				
1,2	x	0,9	B-2409.12				
1,5	x	1,2	B-2409.15				
1,8	x	1,8	B-2409.18	1,8	x	1,8	B-2418.18
2,5	x	2,0	B-2409.25	2,5	x	2,0	B-2418.25
3,0	x	2,0	B-2409.30	3,0	x	2,0	B-2418.30
4,5	x	2,0	B-2409.45				

House-Luer



Wullstein
 16 cm / 6 1/8"
 B-2502.15 Ø 1,5 mm
 B-2502.20 Ø 2,0 mm



Wullstein
 16 cm / 6 1/8"
 B-2506.30



Wullstein
 10,5 cm / 4 1/8"
 B-2510.50



NEGUS
 6 mm
 B - 2512.60
 210 mm, 8 1/4"
 Suction dissector

Handle with thumb valve for Wullstein suction tubes

Aspirating and irrigating instruments Instruments à aspiration et à irrigation Instrumentos de aspiración y de lavado



B-2425.20

Suction Adaptor with Luer tip and thumb valve

- Ø 0,5 mm **B-2431.05**
- Ø 0,6 mm **B-2431.06**
- Ø 0,7 mm **B-2431.07**
- Ø 0,8 mm **B-2431.08**
- Ø 0,9 mm **B-2431.09**
- Ø 1,0 mm **B-2431.10**
- Ø 1,2 mm **B-2431.12**
- Ø 1,4 mm **B-2431.14**
- Ø 1,5 mm **B-2431.15**
- Ø 1,8 mm **B-2431.18**
- Ø 2,0 mm **B-2431.20**
- Ø 2,5 mm **B-2431.25**
- Ø 3,0 mm **B-2431.30**



with LUER-LOCK attachment

Rosen



15 cm/6"
B-2453.66

Aspirating Tube only
(without cannula)

with Luer cone

Zöllner
18,5 cm/7 1/4"
B-2453.07

with detachable fine suction tip Ø 0,7 mm



Zöllner
B-2453.75 Ø 0,5 mm
B-2453.77 Ø 0,7 mm

Micro Suction Cannula only, for Suction Tube, working length 30 mm



1/2

- Ø 2,0 mm = Charr. 6 **B-2461.06**
- Ø 2,6 mm = Charr. 8 **B-2461.08**
- Ø 3,3 mm = Charr. 10 **B-2461.10**

with finger cut-off

with Luer cone

Plester
19 cm/7 1/2"



1/2

Baron (Schuknecht)

Ø charr. x L mm		
3	75	B-2437.03
5	75	B-2437.05
7	75	B-2437.07
3	100	B-2440.03
5	100	B-2440.05
7	100	B-2440.07

Self - retaining retractors
Ecarteurs autostatiques
Separadores autostáticos

4 x 4 teeth sharp



Jansen
 10 cm/4"
 G-5310.11

4 x 4 teeth blunt



Jansen
 10 cm/4"
 G-5311.11

3 x 3 teeth sharp



Jansen
 10.5 cm/4 1/8"
 G-5312.11

3 x 3 teeth blunt



Jansen
 10.5 cm/4 1/8"
 G-5313.11

sharp



Plester
 13 cm/5"
 G-5363.22

blunt



Plester
 13 cm/5"
 G-5363.32

blunt

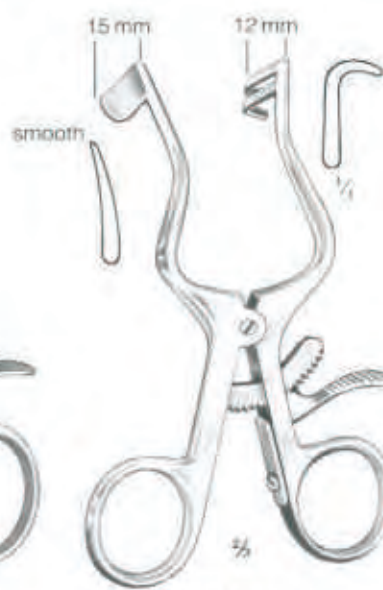

Plester
 11 cm/4 3/8"
 G-5371.02

blunt



Plester
 11 cm/4 3/8"
 G-5371.01

Self - retaining retractors
Ecarteurs autostatiques
Separadores autostáticos

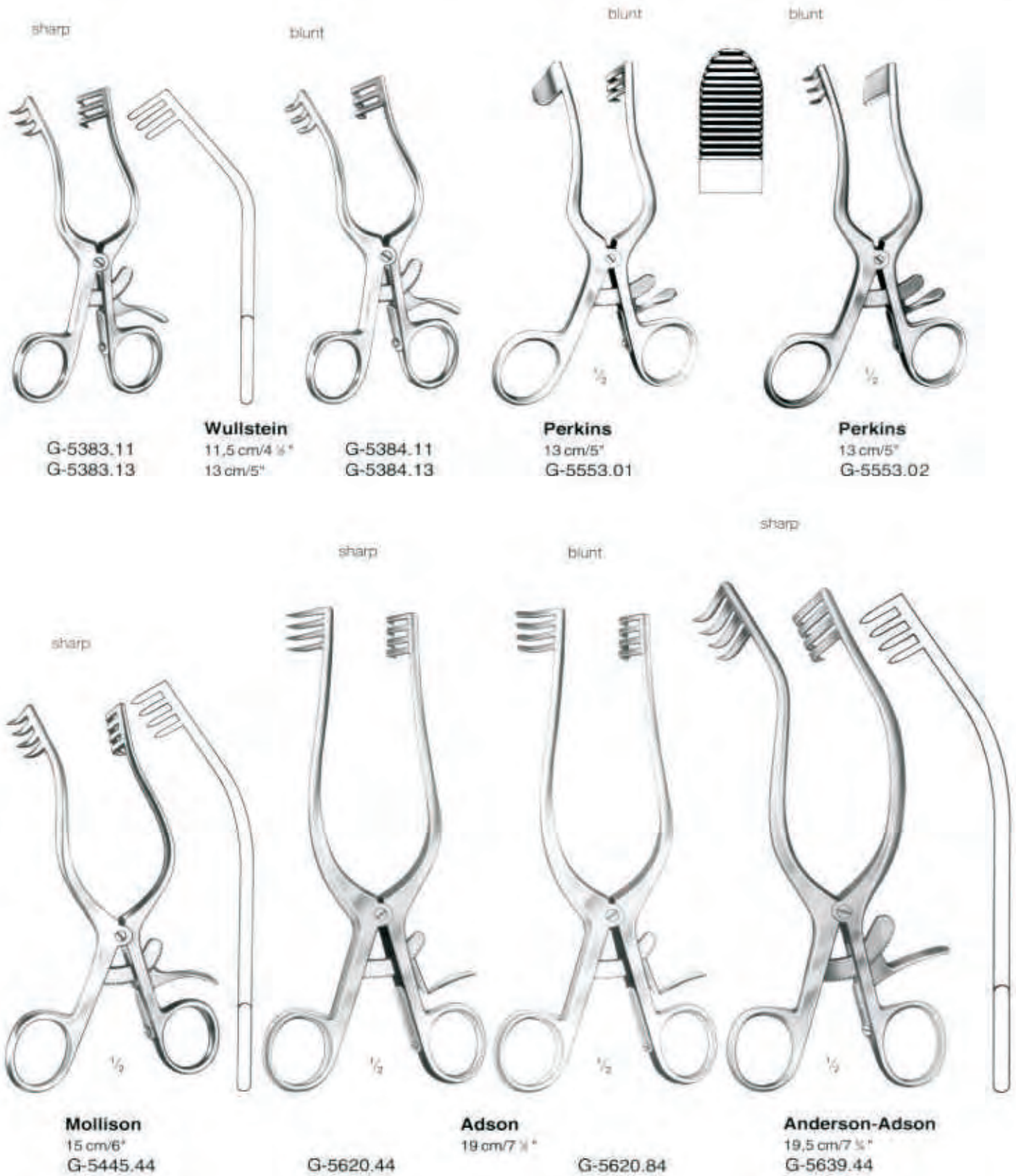

Nasal specula
Spéculums nasaux
Espéculos nasales



Beckmann
 15 cm/6"

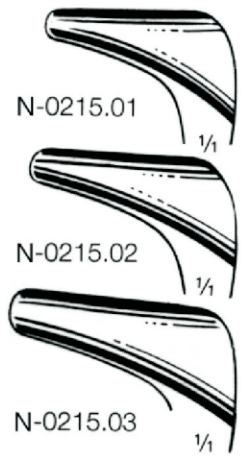

N-0215.01 Fig. 1
 N-0215.02 Fig. 2
 N-0215.03 Fig. 3



Hartmann
 16 cm/6 1/4"



for children

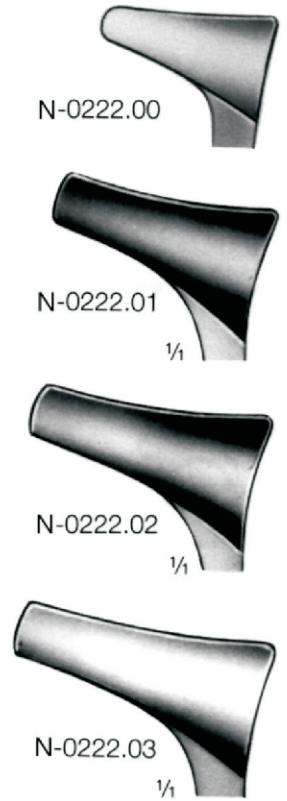

N-0222.00 Fig. 0
 N-0222.01 Fig. 1
 N-0222.02 Fig. 2
 N-0222.03 Fig. 3



Hartmann-Halle
 15 cm/6"
 N-0230.##



N-0230.01 Fig. 1
 N-0231.01 1/1
 N-0230.02 Fig. 2
 N-0231.02 1/1
 N-0230.03 Fig. 3
 N-0231.03 1/1



Hartmann-Halle
 15 cm/6"
 N-0231.##



Sonnenschein
 15 cm/6"

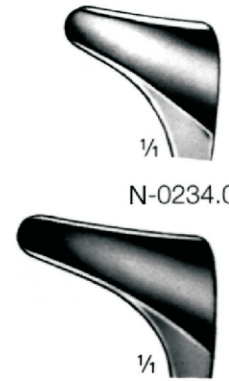

N-0234.01 Fig. 1
 N-0234.02 Fig. 2

Rhinology & Rhinoplasty Instruments

Nasal specula
Spéculums nasaux
Espéculos nasales



Palmer
 N-0116.07



Thudichum (Goldsmith)



N-0132.01



N-0132.02



N-0132.03



Voltolini



N-0140.01



N-0140.02



N-0140.03



Fig 1

N-0204.01



Fig 2

N-0204.02



Fig 3

N-0204.03



Modell Wien (Vienna pattern)
 14 cm/5 1/2"

lightweight

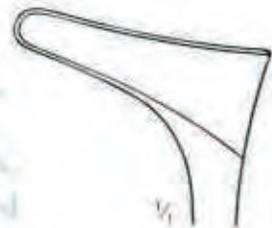

Hartmann/Wiener
 15 cm/6"
 N-0206.15

Nasal specula
Spéculums nasaux
Espéculos nasales

for children



Beckmann
15 cm/6"



N-0215.01 Fig. 1

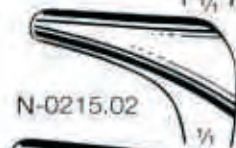

N-0215.02 Fig. 2



N-0215.03 Fig. 3

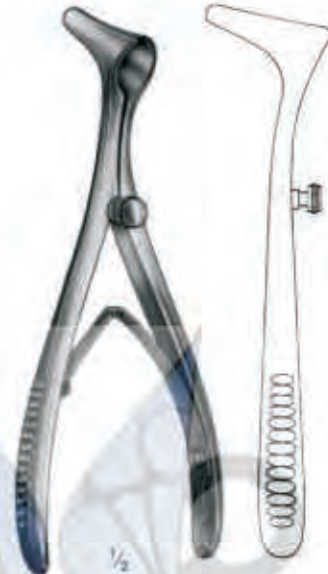

Hartmann
16 cm/6 1/4"



N-0222.00 Fig. 0



N-0222.01 Fig. 1



N-0222.02 Fig. 2



N-0222.03 Fig. 3



Hartmann-Halle
15 cm/6"
N-0230.##



N-0230.01 Fig. 1
N-0231.01 1/4"



N-0230.02 Fig. 2
N-0231.02 1/4"



N-0230.03 Fig. 3
N-0231.03 1/4"



Hartmann-Halle
15 cm/6"
N-0231.##



Sonnenschein
15 cm/6"



Fig. 1
1/4"

N-0234.01



Fig. 2
1/4"

N-0234.02

Nasal specula
Spéculums nasaux
Espéculos nasales



Tieck-Halle
 13,5 cm/5 1/4"



Fig. 1 N-0236.01



Fig. 2 N-0236.02

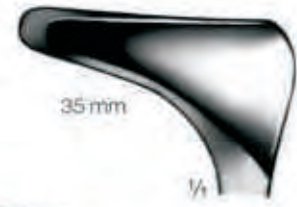

Fig. 1

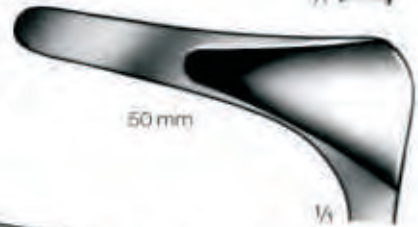

Fig. 2



Fig. 3



Fig. 4



Killian
 13 cm/5"
 Fig. 1 N-0250.35
 Fig. 2 N-0250.50
 Fig. 3 N-0250.75
 Fig. 4 N-0250.90



Killian
 13 cm/5"
 Fig. 1 N-0251.35
 Fig. 2 N-0251.50
 Fig. 3 N-0251.75
 Fig. 4 N-0251.90

MAST PAK
 SURGICAL CORPORATION

**Nasal specula
spéculums nasaux
Espéculos nasales**



Cottle

15 cm/6"

Fig. 1 N-0260.35

Fig. 2 N-0260.50

Fig. 3 N-0260.75

Fig. 4 N-0260.90



35 mm

1/8

Fig. 1



50 mm

1/8

Fig. 2

Nasal Septum Speculum



75 mm

1/8

Fig. 3



90 mm

1/8

Fig. 4



Cottle

15 cm/6"

Fig. 1 N-0261.35

Fig. 2 N-0261.50

Fig. 3 N-0261.75

Fig. 4 N-0261.90



Cottle

15 cm/6"

Fig. 1 N-0264.35

Fig. 2 N-0264.50

Fig. 3 N-0264.75

Fig. 4 N-0264.90

MAST PAK
SURGICAL CORPORATION

**Nasal specula
Spéculums nasaux
Espéculos nasales**

Killian fibre optic nasal speculum

135 mm (5 1/4")
fibre light fitting (3mm)



N-0266.51
Blade:51mm

1/1

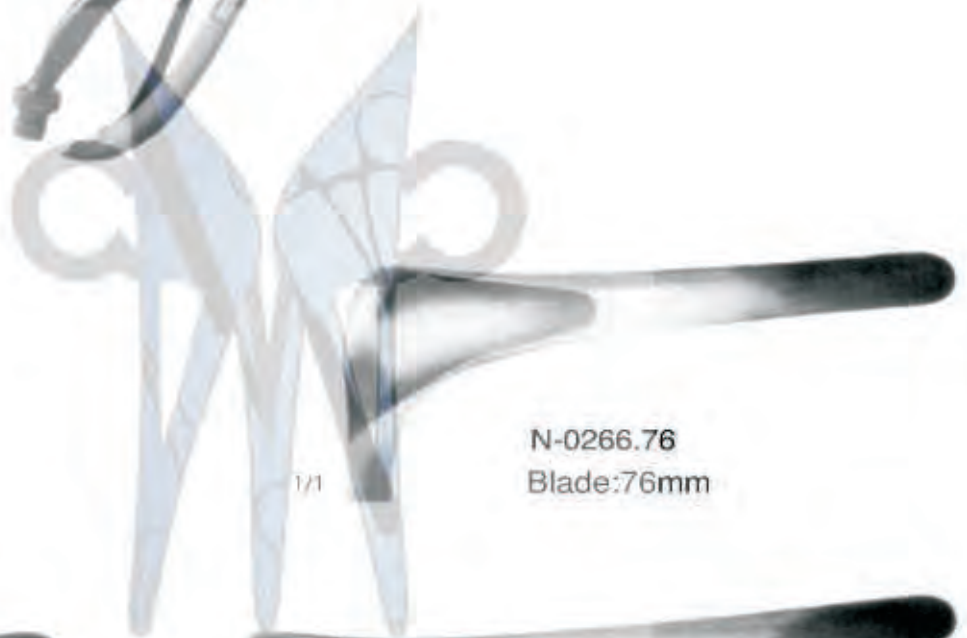

1/1

N-0266.76
Blade:76mm



N-0266.64
Blade:64mm

1/1



N-0266.89
Blade:89mm

1/1

MAST PAK
SURGICAL CORPORATION

Nasal and ethmoid curettes
curettes nasales
curetas nasales y etmoidales



Polypus, tampon and septum compression forceps
Pinces à polypes, porte-tampons et pour la cloison nasale
Pinzas para pólipos, taponamientos y el tabique nasal

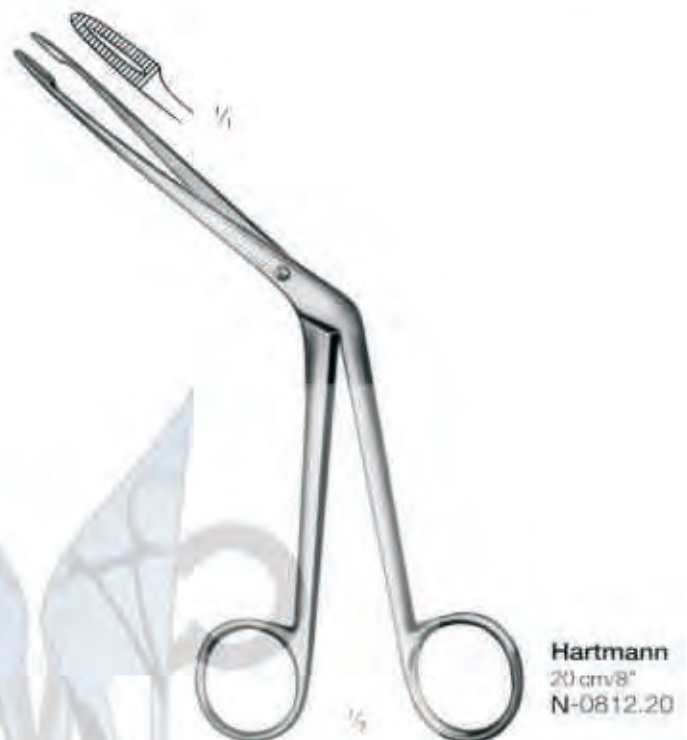

MASTER PAK
 SURGICAL CORPORATION

Nasal polypus snares
Serre-noeuds nasaux
Polipótomos nasales

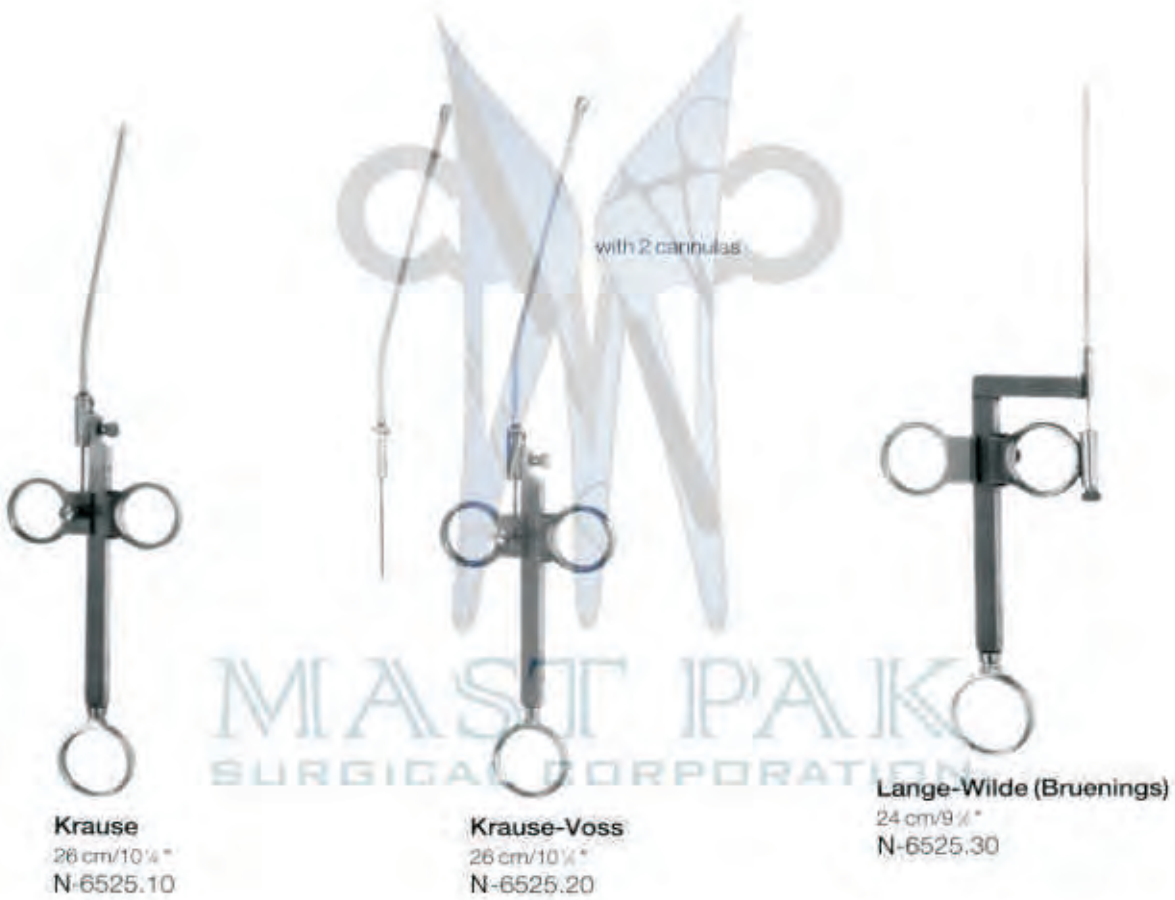

Nasal Scissors
Ciseaux nasaux
Tijeras nasales



Heymann
18 cm/7"
F-2015.18

Knight
18 cm/7"
F-2019.18

Fomon "Saber Back"
13,5 cm/5 1/4"
F-2031.13

Fomon "Upper Lateral"
13,5 cm/5 1/4"
F-2035.13

MASTPAK
SURGICAL CORPORATION

Nasal scissors
Ciseaux nasaux
Tijeras nasales



Fomon
14,5 cm/5 3/4"
F-2051.14

Cottle
17 cm/6 3/4"
F-2055.17

Raspatories, elevators
Raspatoires, décolleurs
Periostótomos, elevadores



Freer
 19 cm/7 1/2"
 J-3179.01



Freer
 19 cm/7 1/2"
 J-3179.02



Freer
 17 cm/6 3/4"
 J-3179.17



Freer
 18 cm/7"
 J-3180.18



Freer
 20 cm/8"
 J-3180.20



Lempert
 20,5 cm/8"
 J-3220.06



Lempert
 18 cm/7"
 J-3218.06



No. 16
 J-3226.16



No. 15
 J-33226.15

Excavator

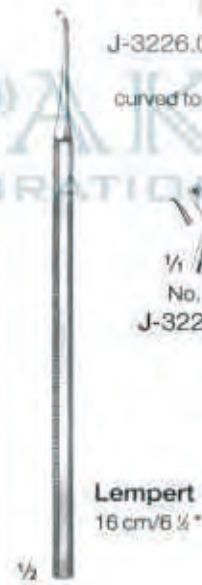

Lempert
 16 cm/6 1/4"

Septum elevators and raspatories
Élévateurs et rugines pour la cilison nasale
Elevadores y legras para el tabique nasal



Dissectors, elevators
Dissecteurs, décolleurs
Disecadores, elevadores



Rhinoplastic knives
Couteaux pour rhinoplastie
Cuchillos para rinoplastía

Rhinoplastic Knives



Rhinoplastic knives
Couteaux pour rhinoplastie
Cuchillos para rinoplastía



Cartilage Knife

Mucous Knives



MASTPAK
 SURGICAL CORPORATION



Septum knives
Bistouris pour la cloison nasale
Bisturías para el tabique nasal



Laminectomy rongeurs
Pinces emporte-pièces à laminectomie
Pinzas cortantes para laminectomía

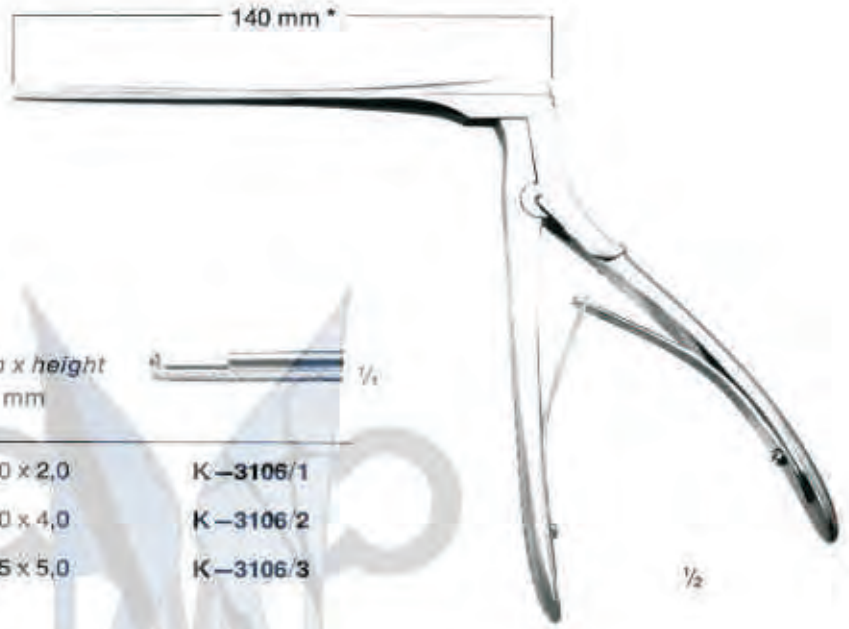

K-3106/1 To K-3106/3
Hajek-Kofler Rongeurs,
*up-cutting, 140 mm long.**

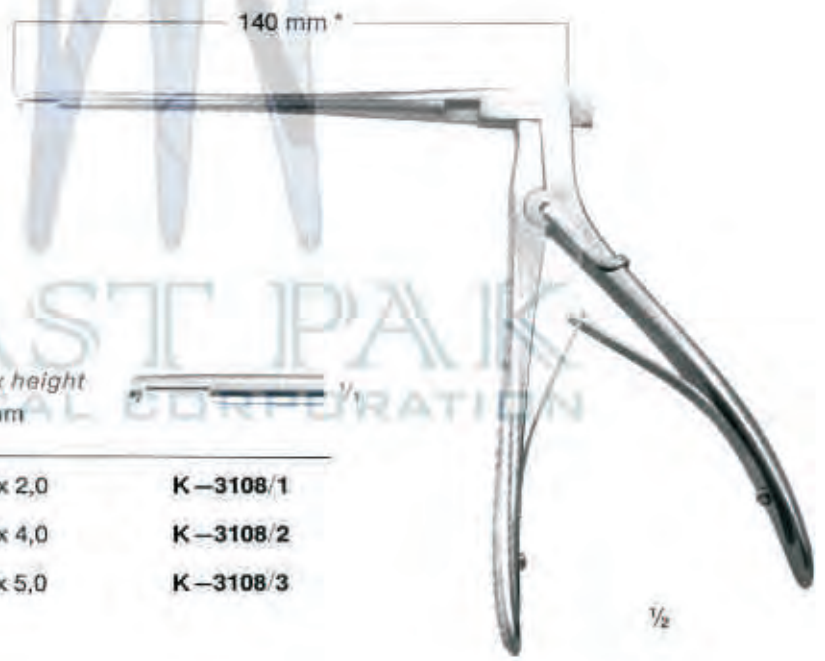

	width x height mm	
	2,0 x 2,0	K-3106/1
	3,0 x 4,0	K-3106/2
	3,5 x 5,0	K-3106/3

K-3108/1 To K-3108/3
Hajek-Kofler Rongeurs,
*down-cutting, 140 mm long.**



	width x height mm	
	2,0 x 2,0	K-3108/1
	3,0 x 4,0	K-3108/2
	3,5 x 5,0	K-3108/3

MAST PAIK
 SURGICAL CORPORATION



Nasal cutting forceps
Pinces coupantes pour le nez
Pinzas cortantes para la nariz



-  N-0960.01
-  N-0960.02
-  N-0960.03
-  N-0960.04
-  N-0960.05



$\frac{1}{4}$ **Weil-Blakesley**



-  N-0961.01
-  N-0961.02
-  N-0961.03
-  N-0961.04
-  N-0961.05

$\frac{1}{4}$ **Weil-Blakesley**



-  2,5x10mm N-1010.25
-  4x10mm N-1010.40

$\frac{1}{4}$ **Takahashi**



-  2,5x10mm N-1011.25
-  4x10mm N-1011.40





$\frac{1}{4}$ **Takahashi**



-  N-0970.01
-  N-0970.02



$\frac{1}{4}$ **Struycken**



-  5mm N-1050.05
-  7mm N-1050.07
-  9mm N-1050.09
-  11mm N-1050.11

$\frac{1}{4}$ **Hartmann**



-  5mm N-1054.05
-  7mm N-1054.07
-  9mm N-1054.09

$\frac{1}{4}$ **Schmeden**

MASTPAK
 SURGICAL CORPORATION

Nasal cutting forceps
Pinces coupantes pour le nez
Pinzas cortantes para la nariz

Antrum Punch, retrograde cutting

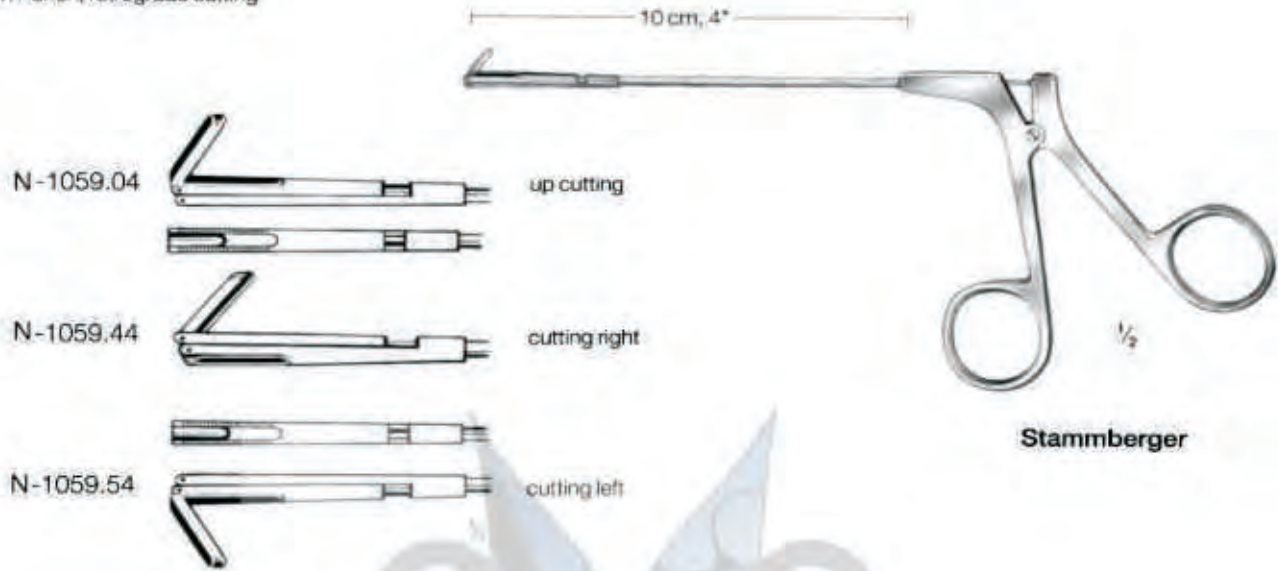



Septum Cutting Forceps



Nasal cutting forceps
Pincès coupantes pour le nez
Pinzas cortantes para la nariz

Sphenoid Punches

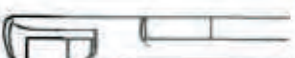
- | | | |
|-------|---|---------------------------|
| ∩ |  | 3,5 x 3,5 mm
N-3175.03 |
| U |  | 3,5 x 3,5 mm
N-3175.13 |
| ∩ |  | 4,0 x 4,0 mm
N-3175.04 |
| 1/2 U |  | 4,0 x 4,0 mm
N-3175.14 |

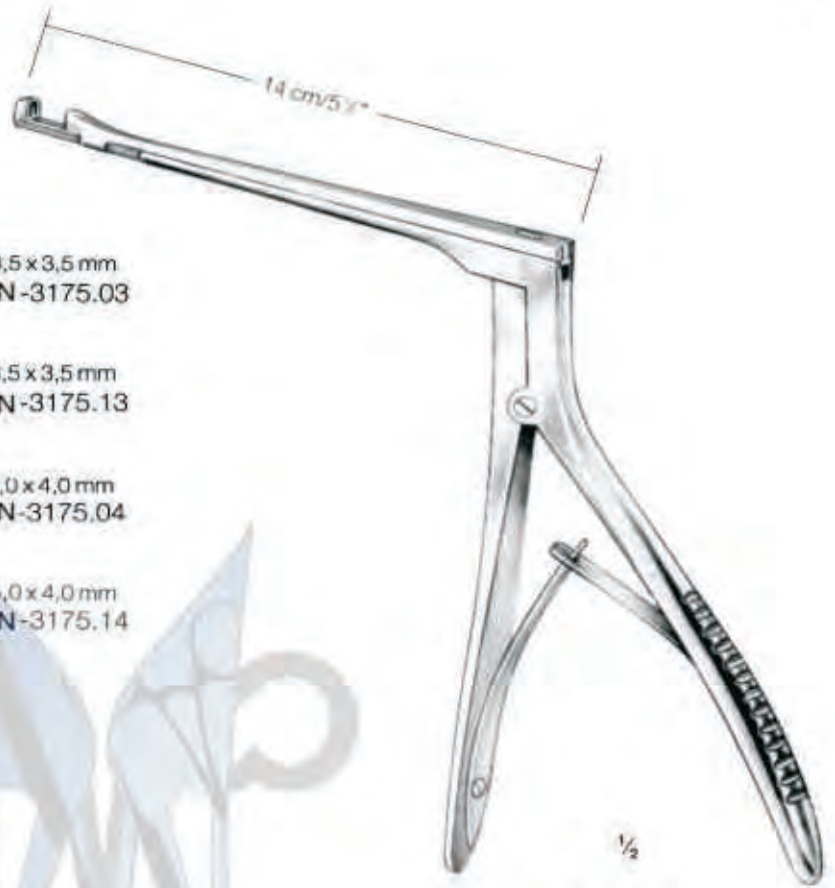

Hajek-Kofler



Hajek-Kofler
N-3188.03

MAST PAK
SURGICAL CORPORATION

Nasal cutting, septum compression and ethmoid forceps
Pincas coupantes para el nez, la cloison nasale et ethmoïdsles
Pinzas cortantes para la nariz, pinzas para el tabique nasal y etmoides

Septum Compression Forceps



Vomer Forceps



Ethmoid Forceps



MAST PAK
SURGICAL CORPORATION

Adenoid curettes, nasal saws
Couteaux à végétations adénoïdes, scies nasales
Cuchillos para vegetaciones adenoideas, sierras nasales

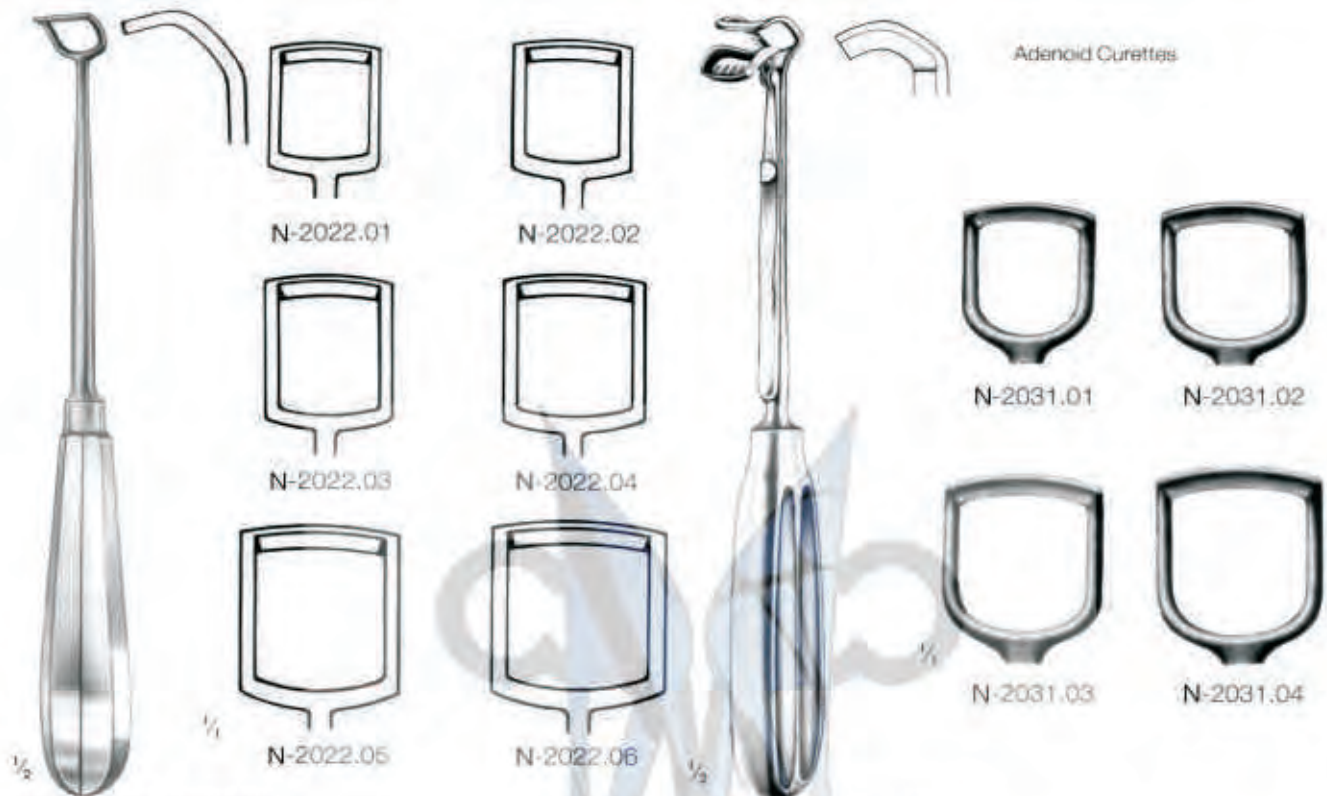

Beckmann-Barnhill
 22 cm/8 1/2" *

St. Clair-Thompson
 21 cm/8 1/4" *



Joseph
 19 cm/7 1/2" *
 N-2200.19

Joseph
 19 cm/7 1/2" *
 N-2219.01

Joseph
 19 cm/7 1/2" *
 N-2219.02

Joseph
 17 cm/6 3/4" *
 N-2227.01

Joseph
 17 cm/6 3/4" *
 N-2227.02

Wound and trachea retractors, mucous hooks
Crochets à plaies et crochets à trachée, crochets pour la muqueuse
Ganchos y separadores para la tráquea, ganchos para las conas



Wound and trachea retractors, ear hooklets
Crochets à plaies et crochets à trachée, crochets auriculaires
Ganchos y separadores para la tráquea, ganchitos auriculares



MASTPAK
 SURGICAL CORPORATION

Fine wound - and trachea retractors
Crochets très fins et crochets à trachée
Ganchos y separadores para la tráquea

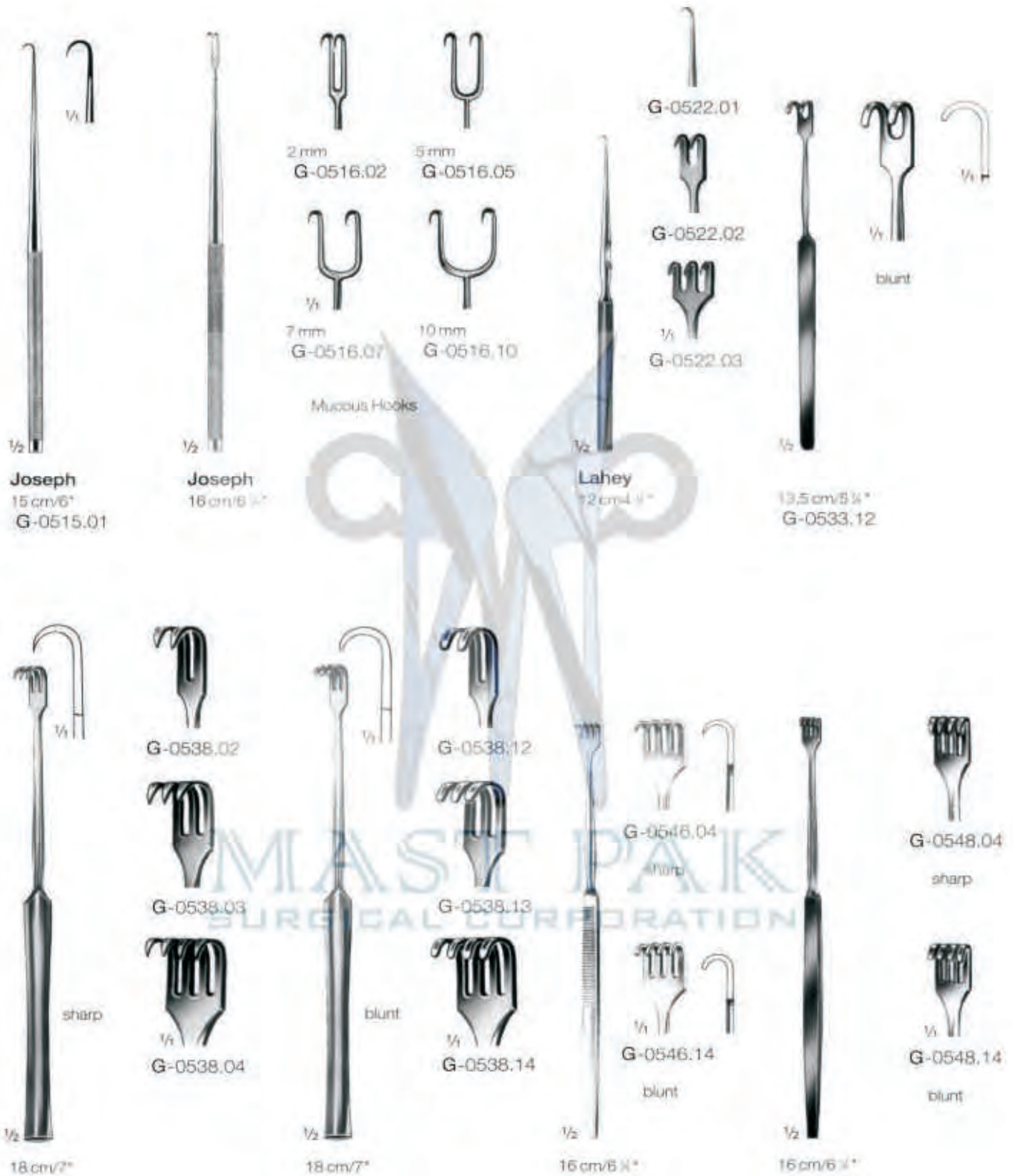

Hooks for posterior nares
Crochets pour les ailes du nez
Separadores nasales



Rasps
Râpes
Raspas

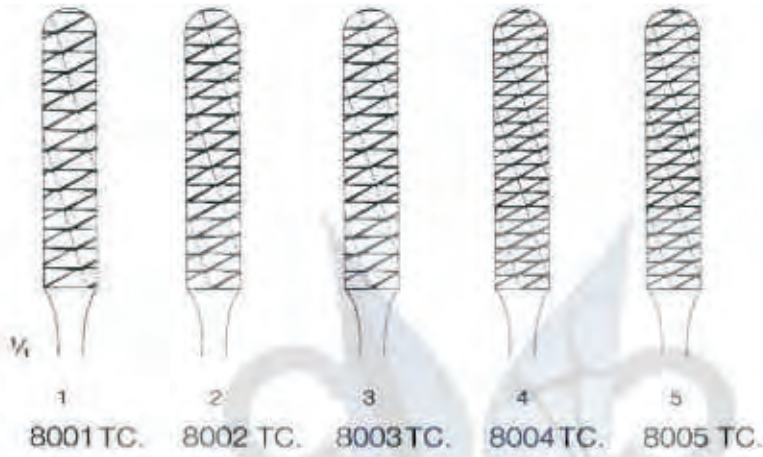

Maltz
18 cm/7\"



Miller

Rasps
Râpes
Raspas



Bone files, rasps
Limes à os, râpes à os
Limas para huesos, escofinas



MASTPAK
 SURGICAL CORPORATION

Raspatories with ferrozell-handle
Raspatoires avec manche Ferrozell
Periostótomos con mangos de Ferrozell (madera artificial)



Rib shears, sternum shears
Costotomes, cisaille à sternum
Costótomos, tijera de esternón



Pin cutters, wire cutters
Pinces coupantes pour fils métalliques
Fórceps para cortar alambre y agujas



23 cm / 9"



Universal

Cottle-Walsham
K-2523.00



left

Walsham
K-2523.01



right

Walsham
K-2523.02



Asch
23 cm / 9"
K-2531.23



14 cm / 5 1/2"
K-3010.14



17 cm / 6 1/2"
K-3020.17



18 cm / 6 3/4"
K-3702.16

MAST PAK
SURGICAL CORPORATION

Bone holding forceps
Daviers
Pinzas para huesos

Bone Holding Forceps



14 cm/5 1/2"
 K-2021.14

Lewin
 18 cm/7"
 K-2027.18

Dingman
 18,5 cm/7 1/4"
 K-2035.19

Dingman
 18,5 cm/7 1/4"
 K-2037.19

Reposition Forceps

Finger Reposition Forceps



Apart
 13,5 cm/5 1/4"
 K-2041.13

14,5 cm/5 3/4"
 K-2043.14

20 cm/8"
 K-2051.20

Sequestrum forceps
Pinces à séquestre
Pinzas para secuestro

Bone holding forceps
Daviers
Pinzas para huesos

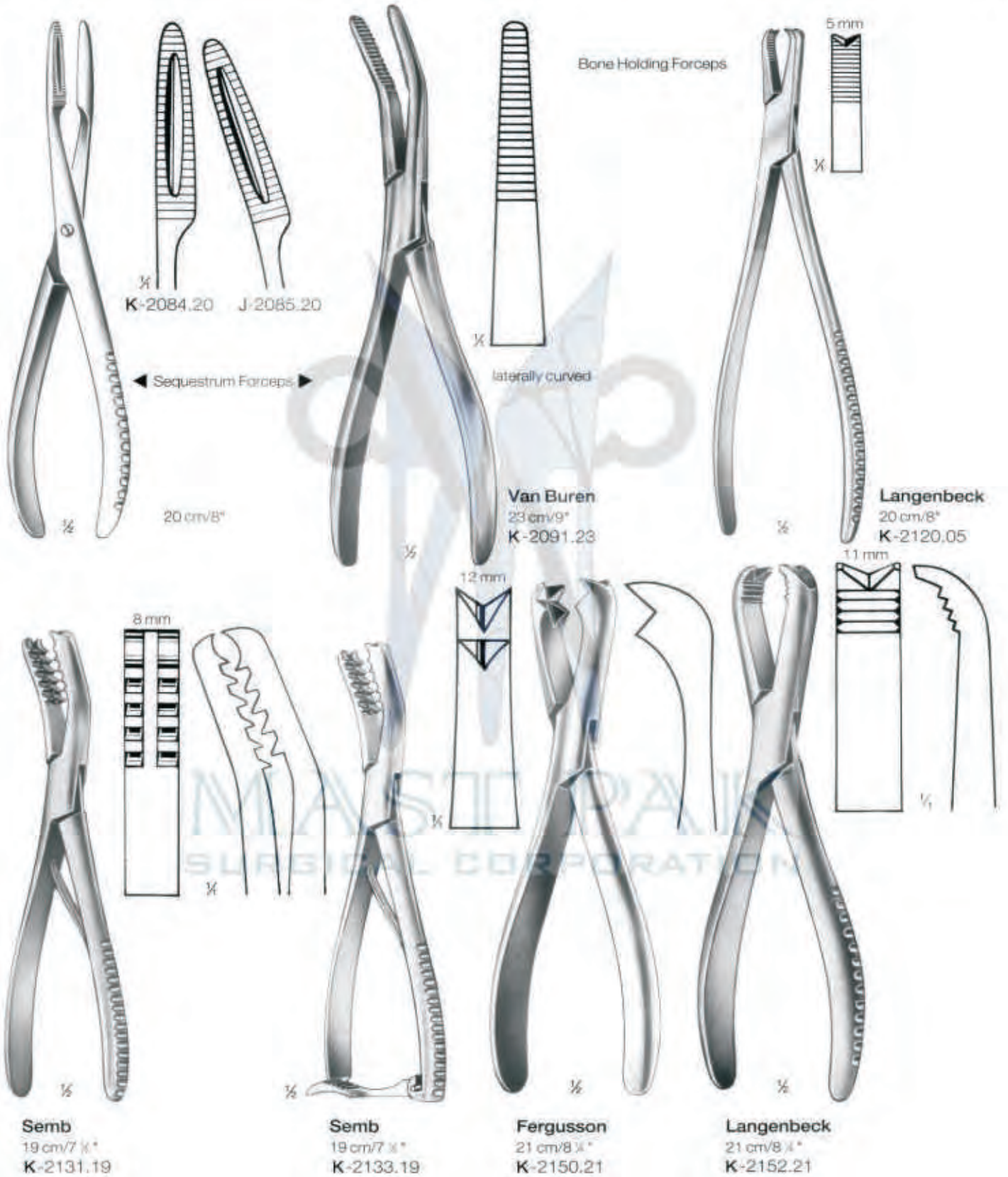

Adenoidectomy_Tonsillectomy Instruments

Tonsil knives
Bistouris pour amygdales
Bisturías para amígdalas



Canfield
 21 cm/8 1/4"
 A-4100.21



straight

Dean
 19 cm/7 1/2"
 A-4130.19



angled

Dean
 19 cm/7 1/2"
 A-4131.19



Bruenings
 23 cm/9"
 A-4150.23



Abraham
 21 cm/8 1/4"
 A-4156.21



saw edge

Fisher
 22.5 cm/9"
 A-4163.22



Tyding
 21 cm/8 1/4"
 A-4171.21



Day
 21.5 cm/8 1/2"
 A-4175.21

MAST PAIK
 SURGICAL CORPORATION

Tongue holding forceps
 Pince tire-langue
 Pinzas tira-lengua

Gelfoam pressure forceps
 Pince à compression pour Gelfoam
 Pinzas de compresión para Gelfoam

Tonsil clamps
 Pincés amygdaliennes
 Pinzas para coger las amígdalas

Tongue Forceps



Young
 17 cm/6 1/2"
 D-8025.17

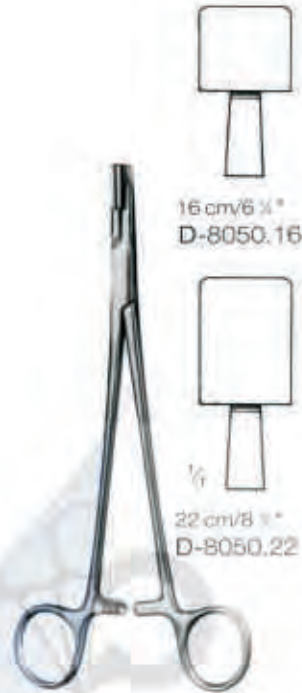

16 cm/6 1/4"
 D-8050.16

22 cm/8 1/2"
 D-8050.22

House

Tonsil Clamps



Schnidt
 19 cm/7 1/2"
 D-0651.19



Schnidt
 (Boettcher)
 19 cm/7 1/2"
 D-8115.19

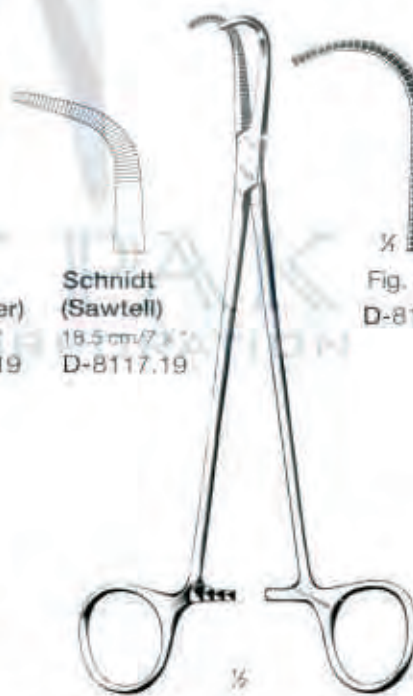

Schnidt
 (Sawtell)
 18.5 cm/7 1/4"
 D-8117.19



Negus
 19 cm/7 1/2"

Tonsil seizing forceps
Pinces pour saisir les amygdales
Pinzas para coger las amígdalas



White
 18 cm/7" D-8225.18
 23 cm/9" D-8225.23



Allis-Coakley
 19 cm/7 1/2" D-8228.19



Allis-Coakley
 19 cm/7 1/2" D-8229.19



Allis-Coakley
 18,5 cm/7 1/4" D-8229.18



Allis
 20 cm/8" D-8231.20



Ballenger
 21,5 cm/8 1/2" D-8241.21



Mikulicz
 18 cm/7" D-8245.18



Blohmke
 20 cm/8" D-8257.20

MAST PAK
 SURGICAL CORPORATION

Suture
Suture
Sutura



Suture
Suture
Sutura



MASTPAK
SURGICAL CORPORATION

Tonsil scissors
Ciseaux pour les amygdales
Tijeras para amigdalas



Good
19 cm/7 1/2"
F-3109.19

Dean
17 cm/6 3/4"
F-3113.17

Tonsil scissors
Ciseaux pour les amygdales
Tijeras para amigdalas



Böttcher
18 cm/7"
F-3125.18

Prince
17,5 cm/6 7/8"
F-3133.17

Wound and trachea retractors, ear hooklets
Crochets à plaies et crochets à trachée, crochets auriculaires
Ganchos y separadores para la tráquea, ganchitos auriculares



MASTPAK
 SURGICAL CORPORATION

Adenoid curettes, nasal saws
Couteaux à végétations adénoïdes, scies nasales
Cuchillos para vegetaciones adenoideas, sierras nasales



Beckmann-Barnhill
 22 cm/8 1/2" *

St. Clair-Thompson
 21 cm/8 1/4" *



Joseph
 19 cm/7 1/2" *
 N-2200.19

Joseph
 19 cm/7 1/2" *
 N-2219.01

Joseph
 19 cm/7 1/2" *
 N-2219.02

Joseph
 17 cm/6 3/4" *
 N-2227.01

Joseph
 17 cm/6 3/4" *
 N-2227.02

Mouth gags, tongue spatulas, tongue depressors
Ouvre-bouches, spatules buccales, abaisse-langues
Abre-bocas, espátulas bucales, baja-lenguas

Mouth Gags



Replacement Silicon-Rubber Tooth Protectors,
 package of 5 pairs

N-0100.50	for	N-0100.10
N-0100.51	for	N-0100.11
N-0100.54	for	N-0100.14

Doyen-Jansen (Molt)

N-0100.10 = 10 cm/4"
 N-0100.11 = 11 cm/4 1/8"
 N-0100.14 = 14 cm/5 1/2"



1/2

Tobold
 14,5 cm/5 3/4"
 N-0200.14



1/2

Moritz-Schmidt
 19 cm/7 1/2"
 N-0209.19



1/2

Hartmann
 15 cm/6"
 N-0215.15



1/2

Wieder
 12 cm/4 3/4"



1/8

29 mm
 N-0224.29



35 mm
 N-0224.35

Tongue depressors, tongue spatulas
Abaisse-langues, spatules buccales
Bajalenguas, espátulas bucales

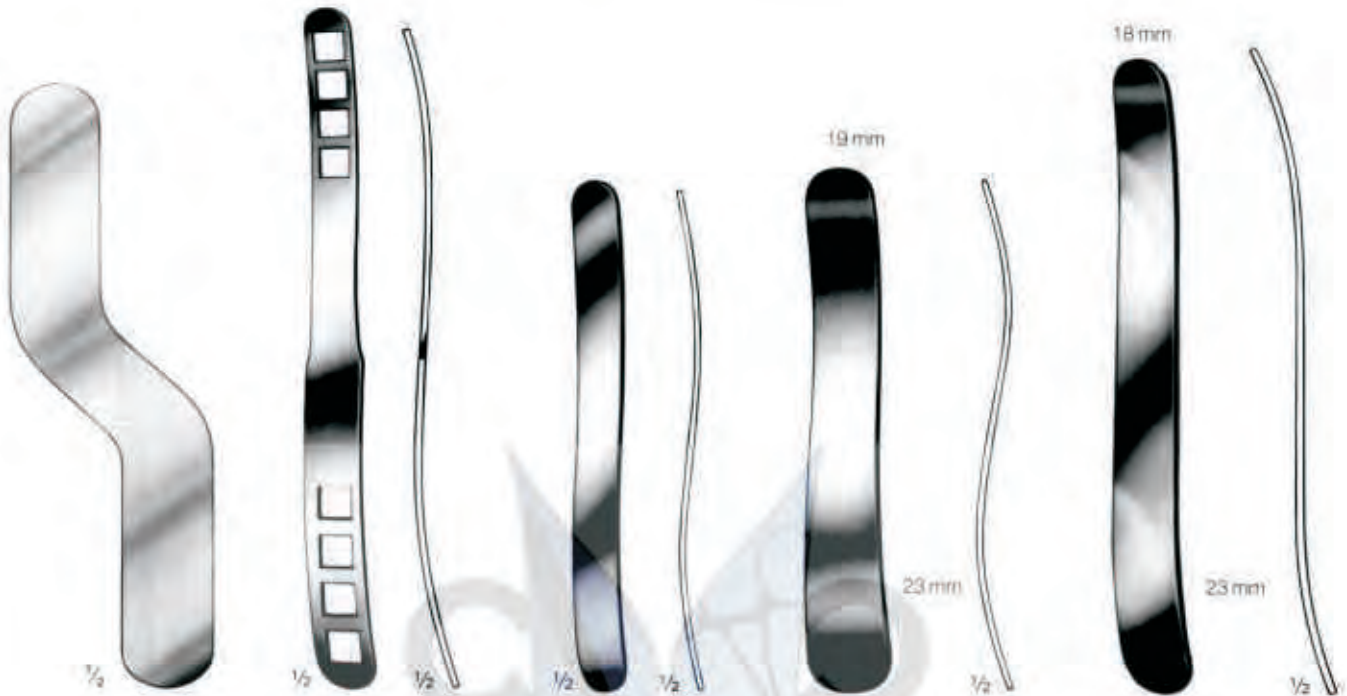

Dutch Pattern
 17 cm/6 1/2"
 N-0248.17

Bruenings
 19 cm/7 1/2"
 N-0250.19

14.5 cm/5 3/4"
 N-0251.14

Kroenig
 15 cm/6"
 N-0252.15

Buchwald
 18 cm/7"
 N-0252.18



14 cm/5 1/2"
 N-0253.14

16 cm/6 1/4"
 N-0255.16

Mayo
 17 cm/6 1/2"
 N-0257.17

Frenzel
 16.5 cm/6 1/2"
 N-0265.16

Maunder

Oral Screws:
 N-0380.40
 of wood
 N-0382.40
 of hard rubber

Tonsillectomy Amygdalectomie Amigdalotomía

Tonsillectomes

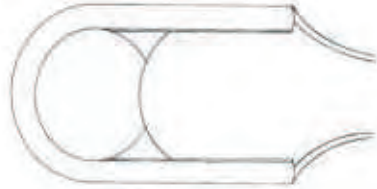

Fig. 1



Fig. 2



Fig. 3

1/4



MAST H&K
SURGICAL CORPORATION

Sluder-Ballenger

N-0516.30

com. with 3 blades.

Fig. 1-3

N-0516.01 blade

Fig. 1

N-0516.02 blade

Fig. 2

N-0516.03 blade

Fig. 3

N-0516.50 handle only



1/2

Sluder-Ballenger

Tonsillectomy Amygdalectomie Amigdalotomía

Tonsil Punch Forceps



Ø 5 mm
N-5504.05

Ø 7 mm
N-5504.07

Ø 9 mm
N-5504.09

Ø 11 mm
N-5504.11

Ø 5 mm
N-5508.05

Ø 7 mm
N-5508.07

Ø 9 mm
N-5508.09



Schmeden

Hartmann

Peritonsillar Abscess Forceps

Tonsil Hemostat



Ø 13 mm
N-5512.13

Ø 15 mm
N-5512.15

Ø 17 mm
N-5512.17



Thilenius
20 cm/8"
N-5525.20



Corwin
14 cm/5 1/2"
N-5546.14

Tonsillectomy Amygdalectomie Amigdalotomía

Tonsil Dissectors, Retractors and Elevators



**Tonsillectomy
Amygdalectomie
Amigdalotomía**

Adenoid Punches:



Ø 11 mm



Hartmann
N-6536.11



11 mm

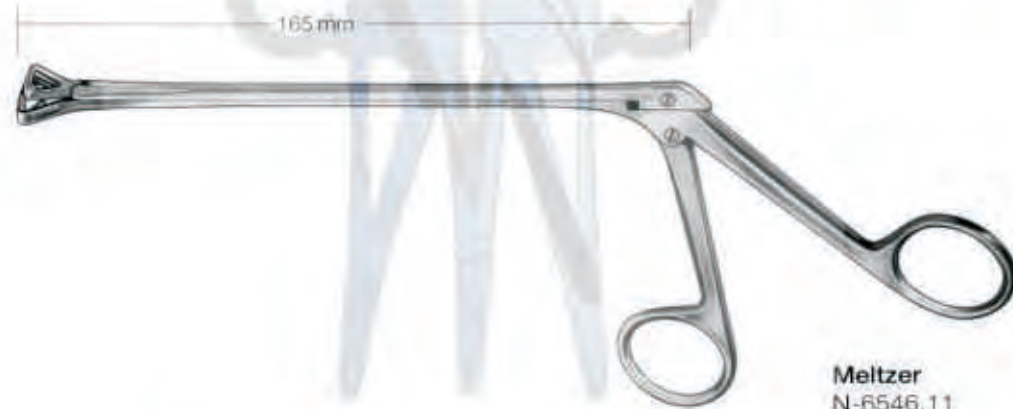

Meltzer
N-6546.11

MASTPAK
SURGICAL CORPORATION



Naso-Pharyngeal Forceps

Jatho
N-6551.13

**Anaesthesia
Anesthésie
Anestesiá**

Mouth Gags



Denhart
12 cm/4 3/4"
O-5100.12

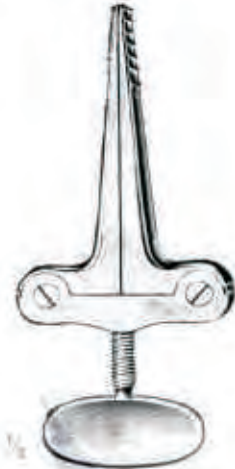

Heister
13 cm/5"
O-5104.13



Rosier-König
18 cm/6 3/4"
O-5110.16



O-5200.11

26 x 108 mm
O-5212.05

25 x 93 mm
O-5212.04

24 x 80 mm
O-5212.03

23 x 65 mm
O-5212.02

26 x 108 mm
O-5210.05

25 x 93 mm
O-5210.04

24 x 80 mm
O-5210.03

23 x 65 mm
O-5210.02

21 x 26 mm
O-5210.01



Davis-Boyle
set cpl.
O-5210.00

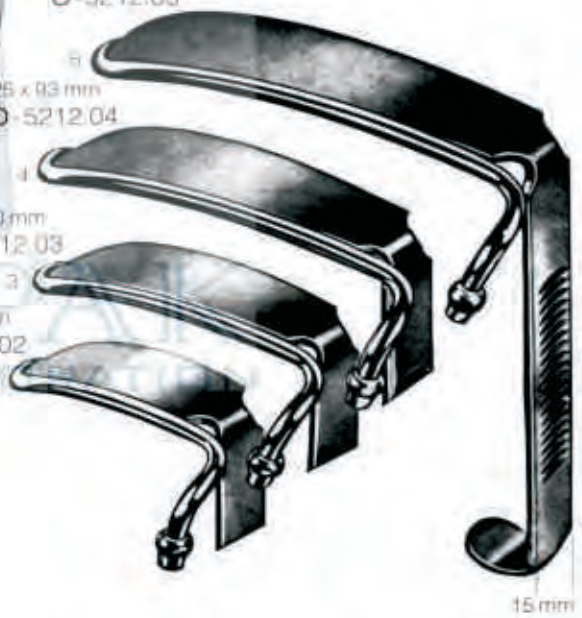

15 mm

**Retractors
Ecarteurs
Separadores**



20 cm/8"
G-2002.20



Kocher
22 cm/8 1/2"
G-2006.10 = 40 x 10 mm
G-2006.15 = 40 x 15 mm
G-2006.20 = 40 x 20 mm



Middeldorpf
G-2010.##



14 x 17 mm
21,5 cm/8 1/2"
◀ G-2010.14
G-2012.14 ▶



20 x 22 mm
22 cm/8 1/2"
◀ G-2010.20
G-2012.20 ▶



26 x 30 mm
23,5 cm/9 1/4"
◀ G-2010.26
G-2012.26 ▶



Middeldorpf
G-2012.##

MASTIPARK
SURGICAL CORPORATION

Nasal cutting, septum compression and ethmoid forceps
Pinces coupantes pour le nez, la cloison nasale et ethmoïdsles
Pinzas cortantes para la nariz, pinzas para el tabique nasal y etmoides

Septum Compression Forceps



Vomer Forceps

Ethmoid Forceps



MAST PAIK
SURGICAL CORPORATION



Mast Pak

Surgical Corporation

Manufacturer & Exporters of surgical instruments

Website: www.mastpaksurgicalcorp.com

Email: info@mastpaksurgicalcorp.com

Phone: +92-324-8609456

Address: Pacca Garha, Kashmir Road
Sialkot 51310, Pakistan